

INSTRUCTION MANUAL

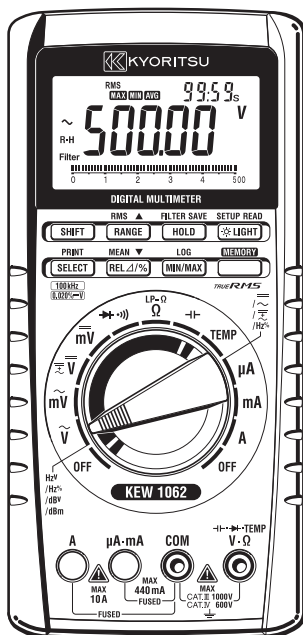

DIGITAL MULTIMETER

KEW 1061 / 1062



**KYORITSU ELECTRICAL
INSTRUMENTS WORKS, LTD.**

Thank you for purchasing our Model KEW1061, KEW1062 Digital Multimeter.

This user's manual describes the specifications and handling precaution for this Digital Multimeter.

Before using this Digital Multimeter, thoroughly read this manual to get a clear understanding on proper use.

Always observe the following instructions.

Failure to do so may impair the protection provided by the instrument and probes, and may result in electrical shock or other dangers that may lead to serious injury or the loss of life.

KYORITSU is in no way liable for any damage resulting from the user's mishandling of the product.

For safe use of this product, the following safety symbols are used on the product:

■ **About This Manual**

- Every effort has been made to ensure accuracy in the preparation of this manual. However, should any errors or omissions come to the attention of the user, please contact KYORITSU.
- The contents of this manual are subject to change without prior notice because of improvement in performance or function.
- All rights reserved. No part of this manual may be reproduced in any form without KYORITSU'S written permission.

Regarding Safe Use of This Product

For safe use of this product, the following safety symbols are used on the product and manual:



WARNING

This indicates that the operator must refer to an explanation in the instruction manual in order to avoid the risk of serious injury or the loss of life.



CAUTION

This indicates that the operator must refer to an explanation in the instruction manual in order to avoid the risk of injury or damage to the product.

Note

This indicates information that is essential for handling the instrument or should be noted in order to familiarize yourself with the instrument's operating procedures and/or functions.



Danger! Handle with Care

This symbol indicates that the operator must refer to an explanation in the instruction manual in order to avoid risk of injury or death of personnel or damage to the instrument.



Double Insulation

This symbol indicates double insulation or reinforced insulation.



Direct Current

This symbol indicates DC voltage/current.



Alternating Current

This symbol indicates AC voltage/current.



DC/AC

This symbol indicates AC and DC.



Fuse

This symbol indicates a fuse.



Battery

This symbol indicates a battery.



Ground

This symbol indicates ground (earth).



WARNING

■ Always observe the following instructions. Failure to do so may result in electrical shock or other dangers that may lead to serious injury or the loss of life.

Test leads / Test leads with crocodile clip (optional accessory)

- Use the probes supplied by KYORITSU with this instrument.
- Do not use test leads/test leads with crocodile clip that have deteriorated or are defective. Check test leads/test leads with crocodile clip continuity.
- Disconnect test leads/test leads with crocodile clip from the circuit under test before opening the casing to replace the batteries or for any other reason.
- Disconnect test leads/test leads with crocodile clip from the circuit under test before attaching/detaching the test leads/test leads with crocodile clip to/from the instrument.
- Disconnect test leads/test leads with crocodile clip from the instrument before opening the casing to replace the batteries or for any other reason.
- A cap is provided on the tip of a test lead. Use a test lead with the cap on for safety (safety standards: IEC 61010-031).
- Do not use the crocodile clip of test leads being loosen or removed conditions.
- Stop using the test lead if the outer jacket is damaged and the inner metal or color jacket is exposed.

Casing

- Do not use the instrument if there is any damage to the casing or when the casing is removed.

Fuses

- Use fuses of the specified rating when the fuse is replaced.

Operating Environment

- Do not operate the instrument in an atmosphere where any flammable or explosive gas is present.
- Avoid using the instrument if it has been exposed to rain or moisture or if your hands are wet.

Disassembly

- No person, except personnel from KYORITSU, is authorized to disassemble this instrument.
-

Contents

1. Overview	65
2. Measurement Category	66
3. Specifications	67
3.1 General Specifications	67
3.2 Accuracy	70
4. Operation	78
4.1 Precautions Before Measurement	78
4.2 Components	79
4.3 Measuring Instructions.....	84
4.3.1 AC Voltage Measurement	84
4.3.2 DC Voltage Measurement	84
4.3.3 DC+AC Voltage Measurement	84
4.3.4 DC, AC Voltage Dual Display	85
4.3.5 Resistance Measurement.....	85
4.3.6 Low Power- Ω	86
4.3.7 Continuity Check	86
4.3.8 Diode Test	87
4.3.9 Temperature Measurement.....	88
4.3.10 Current Measurement	89
4.3.11 DC+AC Current Measurement	90
4.3.12 DC, AC Current Dual Display.....	91
4.3.13 Capacitor Measurement.....	91
4.3.14 Frequency Measurement, Duty cycle ratio.....	92
4.3.15 Function to change RMS detection to/from MEAN detection mode.....	93
4.3.16 Function to turn the filter on/off	93
4.3.17 AUTO HOLD Function	94
4.3.18 PEAK HOLD Function	95
4.3.19 Relative and percentage calculation	95
4.3.20 Decibel calculation	96
4.3.21 MIN/MAX/AVG Function	97
4.4 Memory Function.....	98
4.5 AUTO POWER OFF Function.....	101
4.6 Set-up Function.....	102
4.7 Additional functions simply set when POWER ON.....	105
4.8 Averaging Function.....	105
4.9 5000 display mode	106
4.10 LCD Check	106

5. User Calibration Function.....	107
6. Battery and Fuse Replacement	112
6.1 Battery Replacement.....	112
6.2 Fuse Replacement	113
7. Calibration and Maintenance	114
8. Disposing the Product.....	114

1. Overview

- **Fast and more accurate measurement**

The KEW1061 and KEW1062 digital multimeters use $\Delta\Sigma$ modulation for A/D conversion, which enable fast and more accurate measurement.

- **Display**

5-digit (LCD)

Maximum Reading: 50000

Bar graph indicator

- **Supports a variety of measurement function**

Measurement function

DC Voltage, AC Voltage, DC Current, AC Current, Resistance, Frequency, Temperature, Capacitor, Duty cycle ratio, Decibel (dBV, dBm), Continuity Check, Diode Test, LowPower- Ω^*

Other functions

Data Hold (D•H), Auto Hold (A•H), Peak Hold* (P•H), Range Hold (R•H), Maximum value (MAX), Minimum value (MIN), Average value (AVG), Zero Adjustment (Capacitor, Resistance), Relative values, Save to Memory, LCD backlight.

LowPower- Ω : Measures resistance under low measurement current.

*: For model KEW1062 only

- **Switching detection modes**

Effective value (root mean square value) detection (RMS) and mean value detection (MEAN) can be switched during AC voltage or AC current measurement (KEW1062 only).

- **Low-pass filter**

The low-pass filter can be switched on/off during AC voltage or AC current measurement (KEW1062 only).

- **Communication: optional communication package is required**

- Measurement data can be transferred to a PC using an optional USB communication set. The data can be read by certain applications to make trend graphs or can be converted into Excel files.
- The data can also be output from an optional printer via an optional printer communication set.

- **Safety design**

Complied standards: CE standards

Uses a current-input terminal shutter for preventing wrong input.

Uses high-performance UL-standard fuses.

2. Measurement Category



■ Measurement Category (CAT.)

The restrictions on the maximum voltage level for which the KEW1061, KEW1062 can be used, depend on the measurement categories specified by the safety standards.

Do not apply any input level higher than maximum allowable input.

AC/DC 1000V	CAT III
AC/DC 600V	CAT IV

Measurement category	Description	Remarks	
O	None, Other	Other circuits that are not directly connected to MAINS.	
II	CAT II	For measurements performed on circuits directly connected to the low voltage installation.	Appliances, portable equipment, ect.
III	CAT III	For measurements performed in the building installation.	Distribution board, circuit breaker, ect.
IV	CAT IV	For measurements performed all the source of the low-voltage installation.	Overhead wire, cable systems, ect.

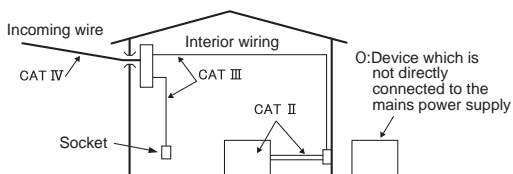

Note

Radiation immunity affects the accuracy of the KEW1061, KEW1062 under the conditions specified in IEC61326-1.

Use of this instrument is limited to domestic, commercial, and light industry applications. If equipment generating strong electromagnetic interference is located nearby, the instrument may malfunction.

3. Specifications

3.1 General Specifications

Measurement function:

DC Voltage, AC Voltage, DC Current, AC Current, Resistance, Frequency, Temperature, Capacitor, Duty cycle ratio, Decibel (dBV, dBm), Continuity Check, Diode Test, LowPower- Ω *

Other functions:

Data Hold (D•H), Auto Hold (A•H), Peak Hold* (P•H), Range Hold (R•H), Maximum value (MAX), Minimum value (MIN), Average value (AVG), Zero Adjustment (Capacitor, Resistance), Relative values, Save to Memory, LCD backlight. LowPower- Ω : Measures resistance under low measurement current.

*: For model KEW1062 only

Measuring method:

$\Delta\Sigma$ modulation

Display:

5-digit (LCD)/7-segment

Maximum Reading: 50000

Polarity Indicator: “-” Appears automatically when the polarity is negative

Overrange Indicator: “OL”

Low-battery Indicator: “+ -” Appears when the batteries become low

Measurement cycle:

6 times per second

(except frequency measurement: one times per second, Resistance measurement : four times per second, capacitor measurement (50mF): max. 0.03 time per second)

Bar graph display 15 times per second

Operating temperature and humidity ranges:

-20 to 55°C, 80%RH or less (no condensation)

70%RH or less at 40 to 55°C.

Température de fonctionnement:

-20 à 55°C

Humidité de fonctionnement:

80% HR ou moins (sans condensation), 70% HR ou moins à 40 ~ 55°C

Storage temperature and humidity ranges:

-40 to 70°C, 70%RH or less (no condensation)

Temperature coefficient:

(Accuracy at 23±5°C) \times 0.05/°C or less

At -20 to 18°C and 28 to 55°C

When continuously DCV and DCA measuring, add 1digit / °C

(except for 50mV, 5A, 10A range, add 3digits / °C).

Power supply:

AA-size (R6) 1.5V batteries: 4

- Battery life: Approximately 100 hours
(Operating hours of alkaline batteries when in DC voltage-mode.)
Note: The battery life varies depending on the operating conditions.
- Insulation resistance : 1000V DC, 100M Ω or more
- Withstand voltage: 6.88kVrms AC for five seconds
(across input terminals and casing)
- External dimensions: Approximately 192(L) \times 90(W) \times 49(D) mm
- Weight: Approximately 560g (including batteries)
- Complied standards: Safety standards
IEC61010-1, IEC61010-2-033, IEC61010-031
CAT III (Max. input voltage: AC/DC1000V)
CAT IV (Max. input voltage: AC/DC600V)
Pollution degree 2, indoor use,
2000m max. above sea level
Utilisation interne 2000m max. au-dessus du niveau de la mer.
- EMC standards
IEC61326-1 Class B
- Effect of radiation immunity:
In the radio-frequency electromagnetic field of 3 V/m, accuracy is within five times the rated accuracy.
- Environmental standard:
EU RoHS Directive compliant

Standard accessories: Batteries : 4

Test leads: 1set (M-7220A)

Fuse (included): 440mA/1000V (M-8926), 10A/1000V (M-8927)

Instruction manual: 1

Optional accessories: Carrying case

M-9154

(for the main unit with test leads
and communication cable)

Test leads (1set)

M-7220A

Test leads with crocodile clip (1set)

M-7234

Fuse

440mA/1000V

M-8926

10A/1000V

M-8927

Temperature probes

M-8405, 8406, 8407, 8408

USB Communication set

M-8241 (Software, USB adapter and
cable)

Printer Adapter and Cable

M-8243

Printer

M-8246

AC adapter (for printer, Europe)

M-8248A

Thermal paper for printer (10 rolls)

M-8247

3.2 Accuracy

Test conditions:

Temperature and humidity: 23±5°C at 80%RH or less

Accuracy: ±(% of reading + digits)

Note: Each response time is a value to rated accuracy within selected range.

DC Voltage Measurement $\square\square\square$ V

Range	Resolution	Accuracy		Input Resistance	Maximum Input Voltage
		KEW1061, KEW1062			
50mV	0.001mV	0.05+10		Approx. 100MΩ	1000V DC
500mV	0.01mV	0.02+2			
2400mV	0.1mV				
5V	0.0001V	0.025+5		10MΩ	1000V rms AC
50V	0.001V	0.03+2			
500V	0.01V				
1000V	0.1V				

NMRR: 80dB or more 50/60Hz ±0.1%

(70dB or more 50/60Hz ±0.1% when 50mV Range)

CMRR: 100dB or more 50/60Hz (Rs=1kΩ)

Response time: 0.3 sec max.

AC Voltage Measurement [RMS] \sim V KEW1061

AC Coupling, Rms-value detection, Crest factor*: <3

Range	Resolution	Accuracy				Input Impedance	Maximum Input Voltage
		10 to 20Hz	20Hz to 1kHz	1k to 10kHz	10k to 20kHz		
500mV	0.01mV	1.5+30 *1	0.7+30 *1		2+50 *2	11MΩ <50pF	1000V rms AC
5V	0.0001V						
50V	0.001V						
500V	0.01V	*2	*2	3+30 *2	10MΩ <50pF	1000V DC	
1000V *	0.1V			-			

*: Crest factor <1.5 at 1000V range

Accuracy *1: At 5 to 100% of range, *2: At 10 to 100% of range

CMRR: 80dB or more DC to 60Hz (Rs=1kΩ)

Response time: 1 sec max.

AC Voltage Measurement [RMS] \sim V

KEW1062

AC Coupling, Rms-value detection, Crest factor*: <3

Range	Resolution	Accuracy						Input Impedance	Maximum Input Voltage
		10 to 20Hz	20Hz to 1kHz	1k to 10kHz	10k to 20kHz	20k to 50kHz	50k to 100kHz		
50mV	0.001mV	2+80 *2	0.4+40 *2	5+40 *2	5.5+40 *2	15+40 *2		11M Ω <50pF	1000V rmsAC
500mV	0.01mV	1+30 *1	0.4+30 *1	1+40 *1	2+70 *2	5+200 *2			
5V	0.0001V								
50V	0.001V								
500V	0.01V	-----		3+30 *2	-		10M Ω <50pF	1000V DC	
1000V*	0.1V	*2	*2						

*: Crest factor <1.5 at 1000V range

Accuracy *1: At 5 to 100% of range, *2: At 10 to 100% of range

CMRR: 80dB or more DC to 60Hz (Rs=1k Ω)

Response time: 1 sec max.

AC Voltage Measurement [MEAN] \sim V

KEW1062



AC Coupling, MEAN value detection, RMS value calibration (sine wave)

Range	Resolution	Accuracy			Input Impedance	Maximum Input Voltage
		10 to 20 Hz	20 to 500 Hz	500Hz to 1 kHz		
50mV	0.001mV	4+80 *2	1.5+30 *2	5+30 *2	11M Ω <50pF	1000V rmsAC
500mV	0.01mV	2+30 *1	1+30 *1	3+30 *1		
5V	0.0001V					
50V	0.001V					
500V	0.01V	-----		*2	10M Ω <50pF	1000V DC
1000V	0.1V	*2	*2			

Accuracy *1: At 5 to 100% of range, *2: At 10 to 100% of range



CMRR: 80dB or more DC to 60Hz (Rs=1k Ω)

Response time: 1 sec max.

DCV+ACV  + 
KEW1061

Maximum Reading 50000, Crest factor*: <3

Range	Resolution	Accuracy				Input Impedance	Maximum Input Voltage
		DC, 10 to 20Hz	DC, 20Hz to 1kHz	DC, 1k to 10kHz	DC, 10k to 20kHz		
5V	0.0001V	1.5+10 *1	1+10 *1	2+10 *2	11MΩ <50pF	1000V rms AC	
50V	0.001V						
500V	0.01V				10MΩ <50pF	1000V DC	
1000V*	0.1V	*2	*2	-			

DCV+ACV  + 
KEW1062

Maximum Reading 50000, Crest factor*: <3

Range	Resolution	Accuracy						Input Impedance	Maximum Input Voltage
		DC, 10 to 20Hz	DC, 20Hz to 1kHz	DC, 1k to 10kHz	DC, 10k to 20kHz	DC, 20k to 50kHz	DC, 50k to 100kHz		
5V	0.0001V	1.5+10 *1	0.5+10 *1	1+10 *1	2+10 *2	5+20 *2	11MΩ <50pF	1000V rms AC	
50V	0.001V								
500V	0.01V						10MΩ <50pF	1000V DC	
1000V*	0.1V	*2	*2	-					

*: Crest factor <1.5 at 1000V range

Accuracy *1: At 5 to 100% of range, *2: At 10 to 100% of range

CMRR: 80dB or more DC to 60Hz (Rs=1kΩ)

Response time: Approx. 2 sec

DC Current Measurement  **A**

Range	Resolution	Accuracy	Voltage Drop	Maximum Input Current
		KEW1061, KEW1062		
500μA	0.01μA	0.2+5	<0.11mV/μA	440mA Protected by a 440mA/1000V fuse.
5000μA	0.1μA			
50mA	0.001mA		<4mV/mA	
500mA*3	0.01mA			
5A	0.0001A	0.6+10	<0.1V/A	10A Protected by a 10A/1000V fuse.
10A	0.001A	0.6+5		

*3: Maximum measurement current : 440mA at 500mA range

Response time: 0.3 sec max.

Note : After measuring over 500mA DC (especially 10A DC), “Zero error” occurs for a while. In that case, please wait for a while at zero input until the value stabilizes before measuring again.

AC Current Measurement [RMS] \sim A
KEW1061

Rms-value detection, Crest factor: <3

Range	Resolution	Accuracy		Voltage Drop	Maximum Input Current
		10 to 20Hz	20Hz to 1kHz		
500 μ A	0.01 μ A	1.5+20	1+20	<0.11 mV/ μ A	440mA Protected by a 440mA/1000V fuse.
5000 μ A	0.1 μ A			<4mV/mA	
50mA	0.001mA			<0.1V/A	
500mA*3	0.01mA				
5A	0.0001A				
10A	0.001A				

AC Current Measurement [RMS] \sim A
KEW1062

Rms-value detection, Crest factor: <3

Range	Resolution	Accuracy			Voltage Drop	Maximum Input Current
		10 to 20Hz	20Hz to 1kHz	1k to 5kHz		
500 μ A	0.01 μ A	1+20	0.75 +20	1+30	<0.11 mV/ μ A	440mA Protected by a 440mA/1000V fuse.
5000 μ A	0.1 μ A				<4 mV/mA	
50mA	0.001mA					
500mA *3	0.01mA					
5A	0.0001A	1.5+20	1+20	2+30	<0.1 V/A	10A Protected by a 10A/1000V fuse.
10A	0.001A					

Model KEW1061/1062

Accuracy At 5 to 100% of range, At 10 to 100% of range for 10A Range

*3: Maximum measurement current : 440mA at 500mA range

Response time: 1 sec max.

AC Current Measurement [MEAN] \sim A
KEW1062

MEAN value detection, RMS value calibration (sine wave)

Range	Resolution	Accuracy			Voltage Drop	Maximum Input Current
		10 to 20Hz	20 to 500Hz	500Hz to 1kHz		
500 μ A	0.01 μ A	2+20	1.5 +20	2+30	<0.11 mV/ μ A	440mA Protected by a 440mA/1000V fuse.
5000 μ A	0.1 μ A					
50mA	0.001mA					
500mA*3	0.01mA					
5A	0.0001A	3+20	2+20	4+30	<0.1 V/A	10A Protected by a 10A/1000V fuse.
10A	0.001A					

Accuracy At 5 to 100% of range, At 10 to 100% of range for 10A Range

*3: Maximum measurement current : 440mA at 500mA range

Response time: 1 sec max.

DCA+ACA \equiv + \sim
KEW1061



Maximum Reading 50000, Crest factor: <3

Range	Resolution	Accuracy		Voltage Drop	Maximum Input Current
		DC, 10 to 20Hz	DC, 20Hz to 1kHz		
500 μ A	0.01 μ A	2+10	1.5+10	<0.11 mV/ μ A	440mA Protected by a 440mA/1000V fuse.
5000 μ A	0.1 μ A			<4mV/mA	
50mA	0.001mA			<4mV/mA	
500mA*3	0.01mA			<0.1V/A	10A Protected by a 10A/1000V fuse.
5A	0.0001A			<0.1V/A	
10A	0.001A				

Accuracy At 5 to 100% of range, At 10 to 100% of range for 10A Range

*3: Maximum measurement current : 440mA at 500mA range

Response time: 2 sec max.

DCA+ACA  + 
KEW1062

Maximum Reading 50000, Crest factor: <3

Range	Resolution	Accuracy			Voltage Drop	Maximum Input Current
		DC, 10 to 20Hz	DC, 20Hz to 1kHz	DC, 1k to 5kHz		
500 μ A	0.01 μ A	1.5+10	1+10	1.5+10	<0.11 mV/ μ A	440mA Protected by a 440mA/1000V fuse.
5000 μ A	0.1 μ A					
50mA	0.001mA					
500mA*3	0.01mA					
5A	0.0001A	2+10	1.5+10	3+10	<0.1 V/A	10A Protected by a 10A/1000V fuse.
10A	0.001A					

Accuracy At 5 to 100% of range, At 10 to 100% of range for 10A Range

*3: Maximum measurement current : 440mA at 500mA range

Response time: Approx. 2 sec

Resistance Measurement Ω

Range	Resolution	Accuracy		Maximum Measuring Current	Open-loop Voltage	Input Protective Voltage
		KEW1061	KEW1062			
500 Ω	0.01 Ω	0.1+2 *1	0.05+2 *1	<1mA	<2.5V	1000V rms
5k Ω	0.0001k Ω					
50k Ω	0.001k Ω					
500k Ω	0.01k Ω					
5M Ω	0.0001M Ω					
50M Ω	0.001M Ω	0.5+2		<1.5 μ A		
		1+2		<0.13 μ A		

*1: Accuracy is specified after zero adjustment (resistance).

Response time: 1 sec max. at 500 Ω to 500k Ω

5 sec max. at 5M Ω to 50M Ω

LowPower- Ω LP- Ω

Maximum Reading 5000

Range	Resolution	Accuracy		Maximum Measuring Current	Open-loop Voltage	Input Protective Voltage
		KEW1062 only				
5k Ω	0.001k Ω	0.2+3		<10 μ A	<0.7V	1000V rms
50k Ω	0.01k Ω					
500k Ω	0.1k Ω					
5M Ω	0.001M Ω					
		1+3		<0.05 μ A		

LowPower- Ω : Measures resistance under low measurement current.

Continuity Check 

Maximum Reading 5000

Range	Resolution	Range of Operation	Measuring Current	Open-loop Voltage	Input Protective Voltage
500Ω	0.1Ω	The buzzer turns on for resistances lower than 100±50Ω.	Approx. 0.5mA	<5V	1000V rms

Diode Test 

Range	Resolution	Accuracy	Measuring Current (Vf=0.6V)	Open-loop Voltage	Input Protective Voltage
2.4V	0.0001V	1+2	Approx. 0.5mA	<5V	1000V rms

Temperature Measurement TEMP

Range	Resolution	Accuracy	Input Protective Voltage
-200 to 1372°C	0.1°C	1%+1.5°C	1000V rms
-328 to 2501.6°F	0.1°F	1%+2.7°F	

Use optional Temperature Probe: Thermocouple Type K

Capacitor Measurement 

Maximum Reading 5000

Range	Resolution	Accuracy	Input Protective Voltage
5nF	0.001nF	1+5 *1	1000V rms
50nF	0.01nF		
500nF	0.1nF		
5μF	0.001μF		
50μF	0.01μF	2+5	
500μF	0.1μF		
5mF	0.001mF	3+5	
50mF	0.01mF		

*1: Accuracy is specified after zero adjustment (capacitor).

Frequency Measurement Hz

AC Coupling, Maximum Reading 9999

Range (AUTO)	Resolution	Accuracy
2.000 to 9.999Hz	0.001Hz	0.02+1 *1
9.00 to 99.99Hz	0.01Hz	
90.0 to 999.9Hz	0.1Hz	
0.900 to 9.999kHz	0.001kHz	
9.00 to 99.99kHz	0.01kHz	----- *2

Accuracy

*1: At 10 to 100% of input voltage or current range

*2: At 40 to 100% of input voltage or current range

Duty cycle ratio %

Range	Resolution	Accuracy
10 to 90%	1%	±1%*1

Accuracy

*1: At 10.00Hz to 500.0Hz, square wave

At 40 to 100% of input voltage or current range

Peak Hold P•H**Model KEW1062 only**

Maximum Reading 5000

Range	Accuracy	Response Time Maximum
DCV, DCA	±100 digit	>250µS

4. Operation

4.1 Precautions Before Measurement

■ Examining Items Contained in the Package

After opening the package, be sure to examine the product as instructed below before use. Should the delivered product be the wrong model, lack any item, or show any flaw in its appearance, contact the vendor from which you purchased the product.

■ Precautions of Operation and Storage



CAUTION

-
- Insert the batteries in the instrument by referring to “6.1 Battery Replacement.”
 - A Blank cover is provided on the upper part of back casing.
Don't remove the Blank cover except when the USB adapter or Printer adapter is connected.
 - Do not use the instrument near noise-emitting equipment or where there may be a sudden change of temperature. Otherwise, the instrument may give an unstable reading or errors.

Removal of Dirt

Do not wipe the instrument using any solvent (chemicals) such as benzine or paint thinner, as this may damage or discolor the front panel.
Use a dry cloth to clean the instrument.

Storage Conditions

- Do not leave the instrument exposed to direct sunlight or in a hot and humid location such as the inside of a vehicle, for any prolonged length of time.
 - If the instrument will not be used for a prolonged period, remove the batteries.
-

4.2 Components

■ Panel Description

■ Test leads

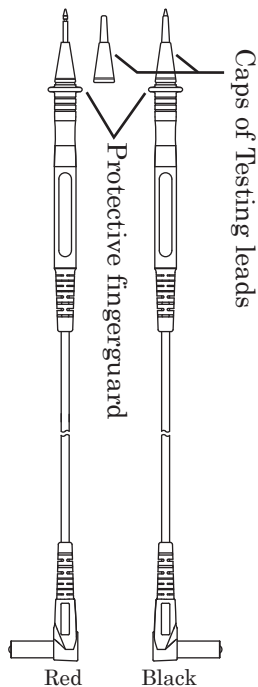
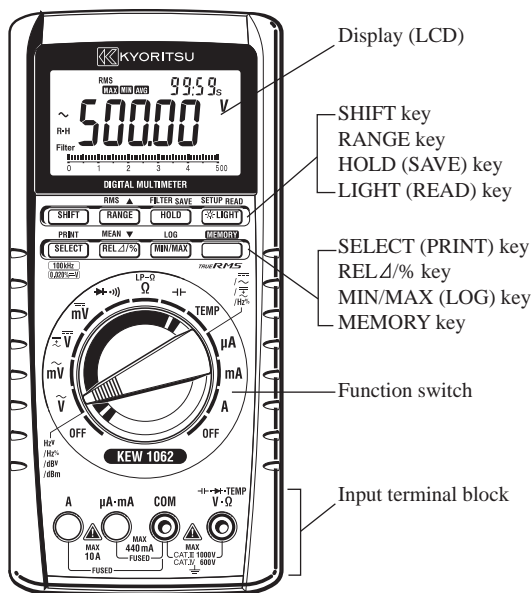

With: 1000V10A CAT. III/600V 10A CAT. IV
 Without: 1000V10A CAT. II/600V 10A CAT. II

■ Test leads with crocodile clip (optional accessory)

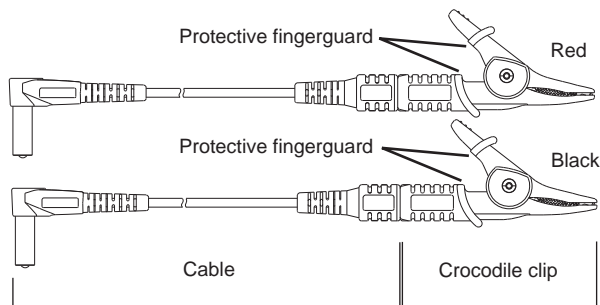

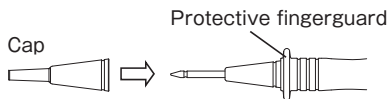

Protective fingerguard (Barrier) :

It is a part providing protection against electrical shock and ensuring the minimum required air and creepage distances.

Cap :

Uncapped condition for CAT II environment

Capped condition for CAT III/ IV environments

The Cap should be firmly attached to the probes.

1) Function switch

Turns off the power or select the measurement mode (function).

OFF	Turns off the power.	Ω	Resistance measurement
\sim V	AC voltage (V) measurement	$\text{---} \text{---}$	Capacitor measurement
\sim mV	AC voltage (mV) measurement	TEMP	Temperature measurement
--- V	DC voltage (V) measurement	μA	DC/AC current measurement
--- mV	DC voltage (mV) measurement	mA	
$\text{---} \leftarrow \rightarrow$	Continuity check, Diode Test	A	

2) SELECT key

Pressing this key in each measurement modes (function)

described above selects other measurement modes (function).

\sim V, \sim mV	1	HzV	: Frequency measurement (Voltage value is displayed.)
	2	Hz%	: Frequency measurement (Duty cycle ratio)
	3	dBV	: dBV measurement (Voltage value is displayed.)
	4	dBm	: dBm measurement
--- V	--- + \sim (DC+AC) measurement, (DC, AC) Dual display		
Ω	LP- Ω (Model KEW1062 only)		
$\leftarrow \rightarrow$	$\text{---} \leftarrow \rightarrow$ Diode Test		
$\mu\text{A}/\text{mA}/\text{A}$	Pressing this key in each measurement modes (function) described above selects other measurement modes (function).		
	1	\sim	: AC voltage measurement
	2	--- + \sim	: (DC+AC) measurement
	3	--- • \sim	: (DC, AC) Dual display
	4	Hz%	: Frequency measurement (Duty cycle ratio)

3) RANGE key

Allows the operator to select the measuring range.

Fixed ranges : The display shows the “ R•H ” symbol.

The range increases every time this key is pressed.

AUTO range : The display shows the “ AUTO ” symbol.

To return to the auto-ranging mode, hold down RANGE key for more than one second.

4) HOLD key

Selects between the DATA HOLD, AUTO HOLD and PEAK HOLD functions. To cancel functions, press this key once again.

DATA HOLD: Holds the display readings.

The display shows the “ D•H ” symbol.

AUTO HOLD: Holds the measured value when the Test leads are handled.

The display shows the “ A•H ” symbol.

PEAK HOLD: Holds the peak value.

The display shows the “ P•H ” symbol. (Model KEW1062 only)

5) LIGHT key

LIGHT key: Use to turn on the LCD backlight.

Press this key once to turn on the LCD backlight for approximately one minute.

The LCD backlight is lit for approximately one minute.

(To postpone turned on time, press this key once again.)

To cancel the function, hold down this key for more than one second.

6) REL Δ / % key

The instrument can calculate relative values or differences, and percentage values from the reference measurement values.

1 : Relative Calculation

The display shows the “ Δ ” symbol.

The sub-display shows the reference voltage value.

2 : Percentage Calculation

The display shows the “ Δ ”, “ % ” symbol.

The sub-display shows the reference voltage value.

7) MIN/MAX key

Displays the minimum value (MIN), maximum value (MAX) and average value (AVG) during measurement.

Pressing this key starts recording and at the same time the display shows MIN/MAX/AVG to release AUTO POWER OFF.

8) MEMORY key

Data can be stored in internal memory using this key.

Used when outputting to printer with the optional adapter and cable.

9) SHIFT key

While this key is pressed, “Shift” appears on the display.

Pressing the following keys with the SHIFT key held down enables the following settings.

SHIFT+	LIGHT key	Set-up function
	RANGE key	Change to [RMS] mode (KEW1062 only)
	REL key	Change to [MEAN] mode (KEW1062 only)
	HOLD key	Turn filter on/off (KEW1062 only)

■ Display (LCD) Description

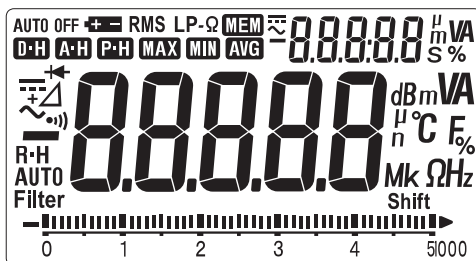

Symbol and Unit	Description
	Appears when in DC-mode measurement
	Appears when in AC-mode measurement
	Appears when in DC+AC-mode measurement
-	Appears when the polarity is negative
	Appears when in diode test
	Appears when in continuity check
Δ	Relative calculation indicator
R•H	Fixed ranges indicator
AUTO	AUTO range indicator
D•H	DATA HOLD indicator
A•H	AUTO HOLD indicator
P•H	PEAK HOLD indicator
MAX	Lit when in MIN/MAX/AVG-mode
MIN	Lit when in MIN/MAX/AVG-mode
AVG	Lit when in MIN/MAX/AVG-mode
MEM	Lit when in Memory function
AUTO OFF	Auto power off indicator
RMS	Appears in RMS mode
LP- Ω	Appears in Low Power- Ω measurement
Filter	Appears while filter is on
Shift	Appears while the SHIFT key is held down
nF, μ F, mF	Unit for capacitance measurement
mV, V	Unit for voltage measurement
μ A, mA, A	Unit for current measurement
M Ω , k Ω , Ω	Unit for resistance measurement
$^{\circ}$ C / $^{\circ}$ F	Unit for temperature measurement
kHz, Hz	Unit for frequency measurement
dB, dBm	Decibel calculation indicator
% (Main-display)	Unit for percentage calculation
% (Sub- display)	Unit for duty cycle ratio calculation
mV, V (Sub- display)	Unit for voltage measurement (dB^{V} , Hz^{V})
s (Sub- display)	Unit for recording time when in MIN/MAX/AVG-mode
(Sub- display)	Recording time indicator when in MIN/MAX/AVG-mode
	Number of saved data indicator
	Reference value indicator when relative calculation
	Duty cycle ratio indicator
	Voltage value (dB^{V} , Hz^{V}) indicator
	Reference resistance value (dBm) indicator
OL	Overrange Indicator
	Appears when the batteries become low
	Bar graph indicator, Range indicator

4.3 Measuring Instructions



To avoid damage to instrument or equipment

- Before starting measurement, make sure that the position of function switch and the input terminals for connecting the test leads are appropriate for the desired mode of measurement.
- Temporarily remove the test leads from the device under test before operating the function switch.
- Verify proper operation on a known source before use or taking action as a result of the indication of the instrument.
- Vérifiez le fonctionnement adéquat sur une source connue avant de procéder tout en basant sur un affichage trompeur de l'instrument." ou une annotation équivalente sera reprise dans le manuel d'utilisation.
- Stop using the test lead if the outer jacket is damaged and the inner metal or color jacket is exposed.
- Arrêtez d'utiliser le cordon de test si la gaine extérieure est endommagée et si la gaine métallique ou interne est exposée.

Test leads here include a test leads with crocodile clip (optional accessory).

4.3.1 AC Voltage Measurement (\sim V, \sim mV)

- 1) Turn the function switch to the " \sim V" or " \sim mV" position.
- 2) Plug the test leads into the input terminals.
- 3) Connect the test leads to the circuit under test and then read the value when it stabilizes.

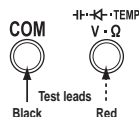

4.3.2 DC Voltage Measurement (--- V, --- mV)

- 1) Turn the function switch to the " --- V" or " --- mV" position.
- 2) Plug the test leads into the input terminals.
- 3) Connect the test leads to the circuit under test and then read the value when it stabilizes.

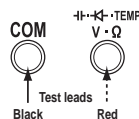

Note

If " --- mV" range is selected and the test leads are left open-circuited, the instrument may give a certain reading. This does not affect your measurement.

4.3.3 DC+AC Voltage Measurement ($\text{---} + \text{~}$)

- 1) Turn the function switch to the “ $\text{---} \text{V}$ ” position.
- 2) Press the SELECT key to select DC+AC voltage measurement.
(The display shows the “ $\text{---} + \text{~}$ ” symbol.)
- 3) Plug the test leads into the input terminals.
- 4) Connect the test leads to the circuit under test and then read the value when it stabilizes.

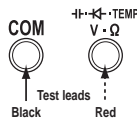

4.3.4 DC, AC Voltage Dual Display ($\text{---} \cdot \text{~}$)

- 1) Turn the function switch to the “DCV” position.
- 2) Press the SELECT key twice to change the mode to DC/AC voltage dual display.
DC voltage measurement appears on the main display and AC voltage on the sub-display.
- 3) Plug the test leads into the input terminals.
- 4) Connect the test leads to the circuit under test and then read the value when it stabilizes.

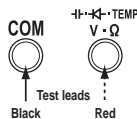

4.3.5 Resistance Measurement (Ω)



CAUTION

To avoid damage to instrument

Turn off the power to the circuit under test before starting measurement in order to prevent any excessive voltage from being applied to the instrument.

- 1) Turn the function switch to the “ Ω ” position.
- 2) Plug the test leads into the input terminals.
- 3) Connect the test leads to the circuit under test and then read the value when it stabilizes.

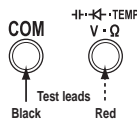

Note

Zero adjustment

Zero adjustment is recommended for correct measurement. After executing 1), 2) above, short the two test leads. Press the REL key for adjust. (The display shows the “0.0 Ω ” value.) The value (zero adjustment) stores till turn off.

4.3.6 Low Power- Ω (LP- Ω)

This function is for measuring the resistance of parts on a printed board under low measurement current.

In Low Power- Ω measurement, up to 5,000 counts are displayed and the measurement range is from 5 k Ω to 5 M Ω .

- 1) Turn the function switch to the “ Ω ” position.
Press the SELECT key to set LP- Ω mode. “LP- Ω ” appears on the display.
- 2) Plug the test leads into the input terminals.
- 3) Connect the test leads to the resistance and then read the value when it stabilizes.

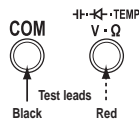

4.3.7 Continuity Check (·))



CAUTION

To avoid damage to instrument

Turn off the power to the circuit under test before starting measurement in order to prevent any excessive voltage from being applied to the instrument.

- 1) Turn the function switch to the “·))” position.
- 2) Plug the test leads into the input terminals.
- 3) Connect the test leads to the circuit under test. If the circuit is continuous (no more than approximately 100 Ω), the buzzer sounds.

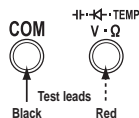

4.3.8 Diode Test (←|→)



CAUTION

To avoid damage to instrument

Turn off the power to the circuit under test before starting measurement in order to prevent any excessive voltage from being applied to the instrument.

1) Turn the function switch to the “←|→ · ·)” position.

Press the SELECT key to select Diode test.

(The display shows the ←|→ symbol.)

2) Plug the test leads into the input terminals.

3) Connect the test leads to the diode and then read the value when it stabilizes.

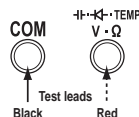

<Forward-bias Diode Test>

Connect the black test lead to the cathode and the red test lead to the anode.

Silicon diodes should give a reading of approximately 0.5V and light-emitting diodes a reading between approximately 1.5V and 2.0V.

<Reverse-bias Diode Test>

Connect the black test lead to the anode and the red test lead to the cathode.

Normally, the display shows the “OL” symbol, indicating that the diode under test is normal. The diode is defective if the display gives a certain voltage level.

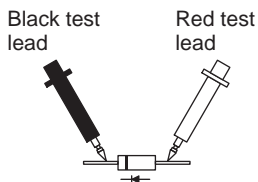

Figure 1 Forward-bias Diode Test

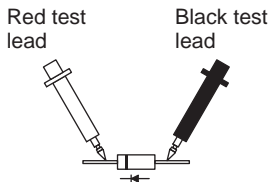

Figure 2 Reverse-bias Diode Test

4.3.9 Temperature Measurement (TEMP)



CAUTION

To avoid damage to instrument

Turn off the power to the circuit under test before starting measurement in order to prevent any excessive voltage from being applied to the instrument.

Note

Optional Temperature probe is required for temperature measurement.

Temperature Probe: Thermocouple Type K

Model: 8405, 8406, 8407, 8408

Check the measurable range of respective probes.

- 1) Turn the function switch to the “TEMP” position.
- 2) Plug the measuring probe into the input terminals.
- 3) Contact the measuring probe to the under test and then read the value when it stabilizes.

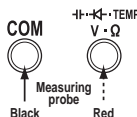

Note

The default temperature read-out of the Digital Multimeters is in Celsius (°C).

To change it to Fahrenheit (°F), it is necessary to proceed as follows:

Changing the temperature unit setting to Fahrenheit

Displaying “°C” only is configured at factory before shipment.

Carry out the following setting procedure to display “°F”.

While pressing the SELECT, RANGE and HOLD keys simultaneously, turn the function switch to the “TEMP” position. Then, upon pressing the SELECT key, the temperature unit switches from °C to °F.

Once the temperature is displayed in °F, press the SELECT key to alternately switch the temperature units between °F and °C.

The conversion from Celsius to Fahrenheit is performed using the equation

Fahrenheit temperature = 1.8×Celsius temperature + 32

4.3.10 Current Measurement ($\mu\text{A}/\text{mA}/\text{A}$)



WARNING

To avoid damage to instrument or equipment

- Before starting measurement, make sure that the position of function switch and the input terminals for connecting the test leads are appropriate for the desired mode of measurement.
- The maximum input current (limited by fuses) of the “ μA ” and “mA” ranges is 440 mA. Be sure not to exceed the limit in the 500 mA range.

Be careful not to burn yourself

- When measuring more than 6A under exceeding 40°C conditions, the continuous measuring time shall be within 3 minutes, then keep disconnected for more than 10 minutes.
- En mesurant plus de 6A dans des conditions en dessous de 40°C, le temps de mesure ininterrompue se situera dans les 3 minutes; déconnectez l'instrument ensuite pendant plus de 10 minutes." ou une annotation équivalente sera reprise dans le manuel d'utilisation.

- 1) Turn the function switch to the “ μA ”, “mA” or “A” position.
(If the magnitude of the current being measured is not known, select the “A” position. Make sure the current being measured is no more than 440mA before the “ μA ” or “mA” position is selected.)
- 2) Please select between DC and AC. When selecting AC, press the SELECT key.
- 3) Plug the black test lead into the “COM” input terminal and the red test lead into the “A” input terminal.
If the current is in the order of mA or less, plug the red test lead into the “ $\mu\text{A} \cdot \text{mA}$ ” input terminal.
- 4) Connect the test leads to the circuit under test and then read the value when it stabilizes.

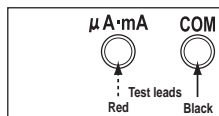
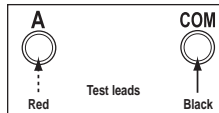

4.3.11 DC+AC Current Measurement ($\text{---} + \text{~}$)



WARNING

To avoid damage to instrument or equipment

- Before starting measurement, make sure that the position of function switch and the input terminals for connecting the test leads are appropriate for the desired mode of measurement.
- The maximum input current (limited by fuses) of the “ μA ” and “mA” ranges is 440 mA. Be sure not to exceed the limit in the 500 mA range.

Be careful not to burn yourself

- When measuring more than 6A under exceeding 40°C conditions, the continuous measuring time shall be within 3 minutes, then keep disconnected for more than 10 minutes.
- En mesurant plus de 6A dans des conditions en dessous de 40°C, le temps de mesure ininterrompue se situera dans les 3 minutes; déconnectez l'instrument ensuite pendant plus de 10 minutes." ou une annotation équivalente sera reprise dans le manuel d'utilisation.

- 1) Turn the function switch to the “ μA ”, “mA” or “A” position.
(If the magnitude of the current being measured is not known, select the “A” position. Make sure the current being measured is no more than 440mA before the “ μA ” or “mA” position is selected.)
- 2) Press the SELECT key twice to select the DC +AC measurement.
(The display shows the $\text{---} + \text{~}$ symbol.)
Plug the black test lead into the “COM” input terminal and the red test lead into the “A” input terminal.
If the current is in the order of mA or less, plug the red test lead into the “ $\mu\text{A} \cdot \text{mA}$ ” input terminal.
- 3) Connect the test leads to the circuit under test and then read the value when it stabilizes.

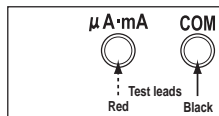
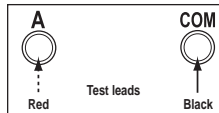

4.3.12 DC, AC Current Dual Display (— — • ~)

- 1) Turn the function switch to the “ μA ,” “mA” or “A” position.
(If the magnitude of the current being measured is not known, select the “A” position. Make sure the current being measured is no more than 440 mA before the “ μA ” or “mA” position is selected.)
- 2) Press the SELECT key three times to select DC/AC dual display.
DC current measurement appears on the main display and AC current on the sub-display.
- 3) Plug the black test lead into the “COM” input terminal and the red test lead into the “A” input terminal.
If the current is in the order of mA or less, plug the red test lead into the “ $\mu\text{A}/\text{mA}$ ” input terminal.
- 4) Connect the test leads to the circuit under test and then read the value when it stabilizes.

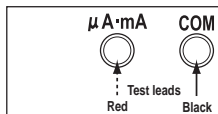
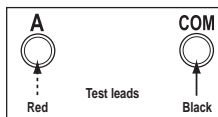

4.3.13 Capacitor Measurement (— | —)



To avoid damage to instrument

- Turn off the power to the circuit under test before starting measurement in order to prevent any excessive voltage from being applied to the instrument.
- Before starting measurement, be sure to discharge the capacitor under check.

- 1) Turn the function switch to the “ — | — ” position.
- 2) Plug the test leads into the input terminals.
- 3) Open the test lead and press the REL key in 5nF range to adjust the capacitance to zero. (The display shows “0.000”.)
- 4) Connect the test leads to the circuit under test and then read the value when it stabilizes.

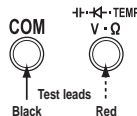

Note

The value (zero adjustment) remains displayed until power-off.

4.3.14 Frequency Measurement (Hz), Duty cycle ratio (Hz)



CAUTION

To avoid damage to instrument

Turn off the power to the circuit under test before starting measurement in order to prevent any excessive voltage from being applied to the instrument.

- 1) Turn the function switch to the voltage (\sim V, \sim mV) or the current (μ A, mA, A) position.
- 2) Press the SELECT key to select the range of frequency. (The display shows the unit of frequency.)
- 3) Plug the test leads into the input terminals.

Plug the red test lead into the suitable input terminal (“A” or “ μ A•mA”) for current value when current measurement.

- 4) Connect the test leads to the under test and then read the value when it stabilizes. The display shows frequency value in main-display and duty cycle ratio value in sub-display.

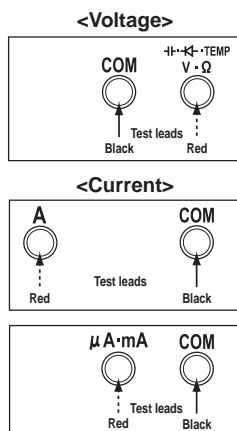

4.3.15 Function to change RMS detection to/from MEAN detection mode (KEW1062 only)

The instrument has a function to change RMS detection to/from MEAN detection modes.

<Change to MEAN detection mode>

- 1) Select the appropriate AC measurement mode (ACV, ACmV, AC μ A, ACmA, ACA) by using the function switch and the SELECT key.
- 2) Press the SHIFT key to display "Shift" on the display.
- 3) Press the REL key while holding down the SHIFT key to change to MEAN detection mode. "RMS" disappears on the display.

<Change to RMS detection mode>

- 1) Select the appropriate AC measurement mode (ACV, ACmV, AC μ A, ACmA, ACA) by using the function switch and the SELECT key.
- 2) Press the SHIFT key to display "Shift" on the display.
- 3) Press the RANGE key while holding down the SHIFT key to change to RMS detection mode. "RMS" appears on the display.

4.3.16 Function to turn the filter on/off (KEW1062 only)

The instrument has a function to turn the filter on/off during AC measurement.

- 1) Select the appropriate AC measurement mode (ACV, ACmV, AC μ A, ACmA, ACA) by using the function switch and the SELECT key.
- 2) Press the SHIFT key to display "Shift" on the display.
- 3) Then press the HOLD key to turn the low-pass filter on.
While the filter on, "Filter" appears on the display.
Refer to filter characteristics in the diagram below.

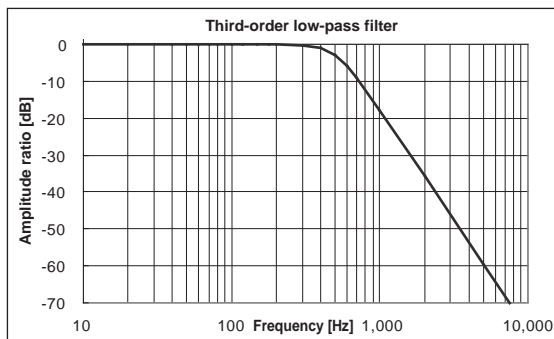

- 4) Repeat step 2) and 3) to turn the filter off.
("Filter" disappears from the display.)

4.3.17 AUTO HOLD Function

The instrument can automatically retain the measured value when the test leads are handled as described below.

- 1) Press the HOLD key to select Auto hold function.
(The display shows the “A•H” symbol.)
- 2) Connect the test leads to the circuit under test.
- 3) When the reading stabilized, the buzzer sounds.
- 4) Remove the test leads from the circuit under test.
- 5) The display shows the measured value that is retained.
You can repeat steps 2) to 4) as many times as you like as long as the display shows the “A•H” symbol.

Note

- In DC/AC voltage measurement, the Auto hold function is only available for ranges greater than the 5V range.
 - This function is not available for Temperature, Capacitor and Frequency measurement.
 - The Auto hold function can not be applied to unstable signals.
-

4.3.18 PEAK HOLD Function

This instrument can always detect, update and display the peak value (instantaneous) in DCV and DCA measurement. The peak value of the wave can be seen.

- 1) Turn the function switch to DCV or DCA position.
- 2) Connect the test leads to the circuit under test.
- 3) Press the HOLD key to select Peak Hold. (The display shows the “P•H” symbol.)
- 4) The display shows the peak value.
- 5) When resetting the peak value in HOLD, press the MIN/MAX key.
Then new peak value can be in HOLD.

Note

Even though the input signals (DCV, DCA) have negative polarity, the peak value can be measured when the peak is in the positive direction.

Relative values from the reference values can be shown during the peak value measuring.

- 1) Press the REL Δ /% key to relative calculation in PEAK HOLD mode.
The display shows the “ Δ ” symbol and the relative peak value.
- 2) Press the REL Δ /% key once again to percentage calculation.
The display shows the “%” symbol and the percentage peak value.

SEE ALSO

Next section “Relative and percentage calculation”

When resetting the peak value, press the MIN/MAX key.
Then new peak value can be in HOLD.

To cancel the percentage calculation, Press the REL Δ /% key again.
“%” symbol disappears, then retrieves the PEAK HOLD mode.

4.3.19 Relative and percentage calculation

The instrument can calculate relative values or difference, and percentage values from the reference measurement values. (The range will be fixed.)

<Relative (REL) calculation>

Subtracts the reference value from the measured value to display the relative value or difference.

- 1) Take a measurement to set the reference value.
- 2) Press the REL Δ /% key.
(The display shows the “ Δ ” symbol and the sub-display shows the reference value.)
- 3) Take another measurement.

<Percentage (%) calculation>

Calculates and display the percentage value according to the following equation: % value
=(measured value – reference value)/reference value

- 1) Take a measurement to set the reference value.
- 2) Press the REL Δ /% key.
(The display shows the “ Δ ” symbol and the sub-display shows the reference value.)
- 3) Take another measurement.
Press the REL Δ /% key again. (The display shows the “ % ” symbol.)

4.3.20 Decibel calculation (dBm, dB^V)

The instrument can perform logarithmic calculations on a AC voltage.

$$\text{dBm} : 20\log \frac{\text{Measured voltage value}}{\sqrt{\text{Reference resistance value} \times 10^{-3}}}$$

(1mW/Reference resistance (Ω)=0dBm)

$$\text{dB}^{\text{V}} : 20\log \frac{\text{Measured voltage value}}{1(\text{V})}$$

- 1) Turn the function switch to the \sim V or \sim mV position.
- 2) Press the SELECT key to select dBm dB^V .
(The display shows the “ dBm ”, “ dB ” symbol.)
- 3) Connect the test leads to the circuit under test and then read the value when it stabilizes.
- 4) When calculating relative value, press the REL Δ /% key.

Note

The instrument can switch (select) reference resistance value when measuring dBm.
The reference resistance value is switched as follows every time the RANGE key is pressed.
(Shown in sub-display.)

Reference resistance value:

4,8,16,32,50,75,93,110,125,135,150
200,250,300,500,600,800,900,1000,1200
Default value: 600 Ω

The default settings can be changed. Refer to the Set-up function.

4.3.21 MIN/MAX/AVG Function

The minimum value (MIN), maximum value (MAX) and average value (AVG) during measurement are shown. (The range is fixed.) The average value is shown by dividing the integrated record data by the number of recording times.

Pressing this key starts recording and at the same time the display shows “MIN”, “MAX” and “AVG” to release AUTO POWER OFF.

<Recording time>

The timer is activated to show the elapsed time from the start and simultaneously the renewed time for MIN/MAX is also recorded.

The elapsed time is displayed as follows:

0 sec. to 99 min. and 59 sec.: steps of 1 sec.

100 min. or more: steps of 1 min.

Press the HOLD key to stop recording. (The display shows the “D•H” symbol.)

<To confirm the recording time>

For confirming the recording time, press the MIN/MAX key.

Subsequent pressing of this key repeats to display the present minimum value (MIN), maximum value (MAX) and average value (AVG).

Press the HOLD key once again to restart recording.

To cancel the confirming mode, hold down the MAX / MIN key for one second.

(“MAX” “MIN” “AVG” symbol disappears.)

Note

- No influence is exerted on the recorded data even if the test leads are disconnected while the recording is stopped.
 - If overload is recorded, the MIN or MAX display changes to “OL” display, resulting in incorrect average data.
 - For widely varying signal measurement, set the appropriate range in which the MAX or MIN does not change to “OL” display.
-

4.4 Memory Function

<To save a Data in internal memory>

The instrument can save a data using with the following two types of modes.

SAVE-mode: Saves a data for one measurement by manual operation.

LOGGING-mode: Automatically saves a data from the start of logging.

Memory capacity

SAVE-mode: 100 data

LOGGING-mode: Logging data of one time Model KEW1061 1,000 data

Model KEW1062 10,000 data

Number of saved data

Number of saved data is 4-digit numbers. When LOGGING-mode, “ L ” is attached to the top of 4-digit numbers. The instrument allocates the smallest number, between 0000 to 9999, that has not yet been used. Use the ▲ (RANGE) key or ▼ (RELΔ/%) key switches the number of saved data.

To save a Data (SAVE-mode)

1) Press the MEMORY key. (The display shows the “ MEM ”symbol.)

2) Press the SAVE (HOLD) key.

(The display shows the number of saved data.)

3) Press the SAVE (HOLD) key to save the data.

Another press of the SAVE (HOLD) key saves a data for the second time measurement or later.

4) To cancel the function, hold down the MEMORY key for one second.

(“ MEM ” symbol disappears.)

Note

HOLD data can be saved.

Hold the display and save it according to the above steps.

The number of saved data

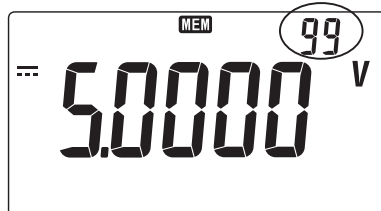

To save a Data (LOGGING-mode)

In logging measurement mode, the time needs to be set. Note that changing the batteries resets the time to 00:00. Set the time by referring to the Set-up function.

- 1) Press the MEMORY key. (The display shows the “MEM” symbol.)
- 2) Press the LOG (MIN/MAX) key.
(The display shows the logging interval (period).)
Set the value with the ▲ (RANGE) key or ▼ (RELΔ/%) key.
The default setting is one second. (The default settings can be changed. Refer to the Set-up function.)
The display shows “FULL” when the logging data is already saved.
When saving the new data, perform delete of data.
- 3) Press the LOG (MIN/MAX) key to start logging. (The “MEM” symbol is flashing.)
Every time the MIN/MAX key is pressed, the sub-display changes.
(Sub display : saved number → saved time (min : sec)→(hour : min)→saved number)
- 4) To cancel the function, hold down the MEMORY key for one second. When memory capacity becomes full, the function is automatically canceled.
(“MEM” symbol disappears.)

Note

LOGGING-mode operation during HOLD-mode disables HOLD-mode.

To load a Data (SAVE-mode)

- 1) Press the MEMORY key. (The display shows the “MEM” symbol.)
- 2) Press the READ (LIGHT) key.
- 3) Press the SAVE (HOLD) key to select the number of saved data.
Select the number with the ▲ (RANGE) key or ▼ (RELΔ/%) key.
- 4) To cancel the function, hold down the MEMORY key for one second.
(“MEM” symbol disappears.)

To load a Data (LOGGING-mode)

- 1) Press the MEMORY key. (The display shows the “MEM” symbol.)
- 2) Press the READ (LIGHT) key.
- 3) Press the LOG (MIN/MAX) key to select the number of saved data.
Select the number with the ▲ (RANGE) key or ▼ (RELΔ/%) key.
Every time the MIN/MAX key is pressed, the sub-display changes.
(Sub display : saved number → saved time (min : sec)→(hour : min)→saved number)
- 4) To cancel the function, hold down the MEMORY key for one second.
(“MEM” symbol disappears.)

<To delete of saving data>

Delete method (SAVE-mode)

- To delete all data

- 1) Press the MEMORY key.
(The display shows the “MEM” symbol.)
- 2) Hold down the SAVE (HOLD) key for one second.
(The display shows the “CLr ?” symbol.)
- 3) Press the SAVE (HOLD) key.
All data is deleted.

- To overwrite selected data

- 1) Press the MEMORY key.
(The display shows the “MEM” symbol.)
- 2) Press the SAVE (HOLD) key.
(The sub-display shows the number of saved data.)
- 3) Use the ▲ (RANGE) key or ▼ (RELΔ/%) key to select the number of saved data.
- 4) Press the SAVE (HOLD) key to save (over write) the data.
- 5) To cancel the function, hold down the MEMORY key for one second.
 (“MEM” symbol disappears.)

Delete method (LOGGING-mode)

- To delete all data

- 1) Press the MEMORY key.
(The display shows the “MEM” symbol.)
- 2) Hold down the LOG (MIN/MAX) key for one second.
(The display shows the “CLr ?” symbol.)
- 3) Press the LOG (MIN/MAX) key.
All data is deleted.



4.5 AUTO POWER OFF Function

<To use the AUTO POWER OFF function>

The display shows the “ AUTO OFF ” indication.

- The instrument automatically turns off twenty minutes after the last key operation.
The instrument will beep for approximately 30 seconds to alert the operator before the AUTO POWER OFF function takes effect.
- Pressing any key or switch while the instrument is beeping postpones the power-off time.
- Turning the function switch once after the power to the instrument is automatically turned off switches the instrument on again.

<To cancel the AUTO POWER OFF function>

- 1) Turn the function switch to the OFF.
- 2) With pressing the HOLD key, turn the function switch to the desired position of any measurement mode (function).

The “ AUTO OFF ” indication turns off when the function is canceled.

Note

Additional functions simply set when POWER ON can be used.

<To enable the AUTO POWER OFF function once again>

- 1) Turn the function switch to the OFF.
- 2) Turn the function switch to the desired position of any measurement mode (function).
The AUTO POWER OFF function is enabled again.
The display shows the “ AUTO OFF ” indication.

4.6 Set-up Function

The following settings can be made using the Set-up function:

- time setting
 - default setting of dBm measurement reference resistance
 - default setting of detection method during AC measurement
 - default setting of LOGGING interval
 - default setting of number display/time display during LOGGING mode
 - sound on/off setting (beep of buzzer)
 - reset to factory preset mode
- 1) Press the SHIFT key shows “Shift” on the display.
 - 2) Press the LIGHT key while holding down the SHIFT key changes the mode to Set-up mode (from Set-up to time display).



- 3) Press the LIGHT key changes the setting items accordingly.
- 4) Change values by using the ▲ (RANGE) key or ▼ (REL) key.
- 5) Press the HOLD key to save/finish each setting.
“SEt” appears and the display returns to the setting items.
- 6) Hold down the LIGHT key for more than one second to return from Set-up mode to measurement mode.

Note

To cancel any setting, hold down the LIGHT key for more than one second, or turn off by using the function key.

<Time setting>

Set the time to be displayed during LOGGING mode. Be sure to set the time after changing the batteries.

- 1) Display “CLOCK” by using the LIGHT key.
The first two digits of the time blink on the sub-display.

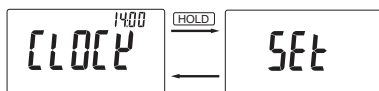

- 2) Set the present hour by using the ▲ (RANGE) key or ▼ (REL) key.
- 3) Press the LIGHT key to make the last two digits blink.
- 4) Set the present minute by using the ▲ (RANGE) key or ▼ (REL) key.
- 5) Press the HOLD key to save the setting.
“SEt” appears and then “CLOCK.”

<Default setting of dBm measurement reference resistance>

Set a default value of the reference resistance during dBm measurement mode.

- 1) Display “db-r” by using the LIGHT key.

The reference value appears on the display.

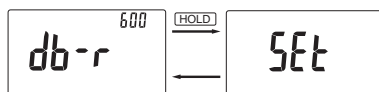

- 2) Select the reference resistance by using the ▲ (RANGE) key or ▼ (REL) key.

- 3) Press the HOLD key to save the setting.

“SEt” appears and then “db-r.”

Setting values of reference resistance

4, 8, 16, 32, 50, 75, 93, 110, 125, 135, 150, 200, 250, 300, 500, 600, 800, 900, 1000, 1200Ω (default value is 600Ω)

<Default setting of detection method during AC measurement> (KEW1062 only)

Set a default setting of detection methods during AC measurement.

RMS or MEAN: The default setting is RMS.

- 1) Display “Ac” by using the LIGHT key.

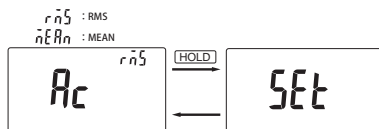

- 2) Select the detection method by using the ▲ (RANGE) key or ▼ (REL) key.

- 3) Press the HOLD key to save the setting.

- 4) “SEt” appears and then “Ac.”

<Default value of LOGGING interval>

Set a default value of the saving interval during LOGGING mode.

- 1) Display “LG. int” by using the LIGHT key.

The default setting is 1 sec.

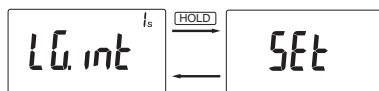

- 2) Select the saving interval by using the ▲ (RANGE) key or ▼ (REL) key.

- 3) Press the HOLD key to save the setting. “SEt” appears and then “LG. int.”

Settings of saving interval

1, 2, 5, 10, 30, 60, 600, 1800 sec

<Default setting of number display/time display during LOGGING mode>

Set the sub-display during LOGGING mode.

(The numbers of saved data or time (minute : second))

Default is the numbers of saved data.

1) Pressing the LIGHT key shows “LG. Unt” on the display.

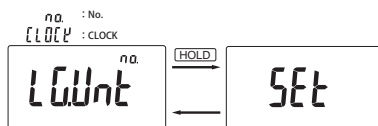

2) Select the desired setting by using the ▲ (RANGE) key or ▼ (REL) key.

3) Press the HOLD key to save the setting.

“SET” appears and then “LG. Unt.”

<Sound on/off setting>

Set the sound on/off (beep of buzzer)

Even if the user sets the sound off, it goes off at the following points.

- checking continuity
- alarm for over-input
- alarm for auto power-off

1) Pressing the LIGHT key shows “bEEP” on the display.

Set on/off on the sub-display. Default is ON.

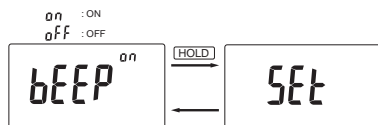

2) Select on/off by using the ▲ (RANGE) key or ▼ (REL) key.

3) Press the HOLD key to save the setting.

“SET” appears and then “bEEP.”

<Reset to factory preset mode>

Reset all the settings to factory preset mode except for time.

1) Pressing the LIGHT key shows “dEF.” on the display.

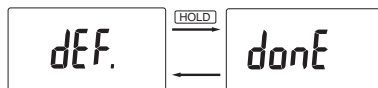

2) Press the HOLD key to reset the settings.

“done” appears and then “dEF.”



CAUTION

To avoid damage to instrument

When the measurement function is completed, turn the function switch back to the OFF position to turn off.

4.7 Additional functions simply set when POWER ON

With pressing the following keys, turn the function switch to the desired position of any measurement mode (POWER ON-state).

This enables the following functions corresponding to the press keys.

Keys	Functions to be set
MIN/MAX	Averaging Function (calculates the average of 8 times)
RANGE	5000 (3.5-digit display)
SELECT	LCD check (Lit only while pressing the SELECT key)
HOLD	Cancels the Auto power off function
HOLD + RELΔ/%	Reset all calibration values to those before shipment.
SELECT + RANGE	Calibration function

4.8 Averaging Function

The measured value may greatly fluctuate, the instrument can calculate the average (8 times / approx. 2 seconds).

This function is available for Voltage, Current and Resistance-mode measurement.

The function (averaging) operates until the power is turned off.

Note

Additional functions simply set when POWER ON can be used.

4.9 5000 display mode

This function switches 3.5-digit display (5000) and 5-digit display (50000).

The function is not available for Capacitor, Temperature, DC+AC, Continuity and Frequency-mode measurement.

The function (5000 display) operates until the power is turned off.

Note

Additional functions simply set when POWER ON can be used.

4.10 LCD Check

The instrument can lit all segments and mark for LCD check.

(Lit only while pressing the SELECT key.)

5. User Calibration Function

It is recommended that the instrument be calibrated periodically.

The instrument can be calibrated.



CAUTION

To avoid electrical shock

- Only authorized engineers are allowed to calibrate the instrument using dedicated facilities.
 - Connect the calibrator to the instrument with the calibrator's test leads.
 - Before carrying out calibration, read the instruction manual of the calibrator.
 - Temporarily remove the test leads from the instrument before switching measurement mode (function).
-

<Conditions of calibration>

Calibrator: With accuracy higher than of this instrument

Ambient Environment:

Temperature: $23\pm 3^{\circ}\text{C}$

Humidity: 55%RH or less

Leave the instrument for 30 minutes under above conditions

before carrying out calibration.

After reference valve of Calibrator stabilizes, Press the key to confirm for calibration valve.

<Table 1>

Carry out calibration of ranges in accordance with Table 1.

Calibration for 2 points (Input 1 and Input 2) is required other than DC range.

After Input 1, carry out calibration of Input 2 repeating steps 6) and 7).

For AC voltage and AC current ranges (marked with \odot), calibration is carried out at 50Hz or 60Hz frequency.

1) Turn the function switch from the OFF position to the \equiv mV position while pressing the SELECT and RANGE keys at the same time.

The display shows the "CAL" symbol then the "PASS" symbol.

2) Press the SELECT key. (The display shows the "-" symbol.)

3) Press the HOLD key twice. (The display shows the "---" symbol.)

4) Press the RANGE key. (The display shows the "mV" symbol.)

5) Connect the instrument to the calibrator with the test leads.

6) Set the calibrator to Input 1 value as an input to the instrument.

7) Press the HOLD key.

8) Be sure to confirm that the function switch and input terminal are set to the desired range.

Carry out calibration of other ranges by repeating steps 6) and 7).

9) To quit calibration, turn the function switch back to the OFF position.

Note

The model KEW1062 needs to be calibrated at mean value detection (MEAN) mode and filter on of AC current.

Table 1. Input Signal for Calibration

Range	Input 1	Input 2	Unit
DC 50mV	0.000	50.000	mV
DC 500mV	500.00	-	mV
DC 2400mV	2000.0	-	mV
DC 5V	5.0000	-	V
DC 50V	50.000	-	V
DC 500V	500.00	-	V
DC 1000V	1000.0	-	V
○ AC 50mV*1	5.000	50.000	mV
○ AC 500mV	50.00	500.00	mV
○ AC 5V *2	0.5000	5.0000	V
○ AC 50V	5.000	50.000	V
○ AC 500V	50.00	500.00	V
○ AC 1000V	100.0	1000.0	V
500Ω	0.00	500.00	Ω
5kΩ	0.0000	5.0000	kΩ
50kΩ	0.000	50.000	kΩ
500kΩ	0.00	500.00	kΩ
5MΩ	0.0000	5.0000	MΩ
50MΩ	0.000	30.000	MΩ
Continuity Check (∩)	0.0	500.0	Ω
DC 500 μA	0.00	500.00	μA
DC 5000 μA	0.0	5000.0	μA
DC 50mA	0.000	50.000	mA
DC 500mA	0.00	400.00	mA
DC 5A	0.0000	5.0000	A
DC 10A	0.000	10.000	A
○ AC 500 μA	50.00	500.00	μA
○ AC 5000 μA	500.0	5000.0	μA
○ AC 50mA	5.000	50.000	mA
○ AC 500mA	50.00	400.00	mA
○ AC 5A	0.5000	5.0000	A
○ AC 10A	1.000	10.000	A

*1: For model KEW1062.

*2: For model KEW1062. Calibration points added in 5 V AC range (setting, input value).

○ [RMS], Filter OFF, Input1 (0.50000), Input2 (5.0000)

○ [MEAN], Filter OFF, Input1 (0.50000), Input2 (5.0000)

○ [RMS], Filter ON, Input1 (0.5000) , Input2 (5.0000)

<Table 2>

After completing the calibration for ranges in Table 1, carry out calibration for “Frequency Characteristic”.

The calibration for is frequency characteristic required for AC voltage and AC current ranges (marked with ○).

Calibration is carried out at the designated frequency in table 2.

- 1) Set the calibrator to Input value as an input to the instrument.
- 2) Press the MEMORY key.
- 3) After 20 seconds, buzzer sounds and the instrument confirm calibration.
(Do not next key operation till buzzer sounds.)

Table 2. Input Signal for Calibration

Range	Input	Unit
○ AC 50mV*1	50.000	mV
○ AC 500mV	500.00	mV
○ AC 5V	5.0000	V
○ AC 50V	50.000	V
○ AC 500V	500.00	V
○ AC 1000V 600Hz	1000.0	V
○ AC 500μA	500.00	μA
○ AC 5000μA	5000.0	μA

*1: For model KEW1062.

● Calibration of Capacitor Range

Before start calibration of the Capacitor range,
turn the function switch back to the OFF position.

- 1) Turn the function switch from the OFF position to the ---| (Capacitor) position while pressing the SELECT and RANGE keys at the same time.
The display shows the “ CAL ” symbol then the “ PASS ” symbol.
- 2) Press the SELECT key. (The display shows the “ - ” symbol.)
- 3) Press the HOLD key twice. (The display shows the “ - - - ” symbol.)
- 4) Press the RANGE key. (The display shows the “ nF ” symbol.)
- 5) Connect the instrument to the calibrator with the test leads.
- 6) Set the calibrator to Input 1 value as an input to the instrument.
- 7) Press the HOLD key to confirm.
- 8) Set the calibrator to Input 2 value as an input to the instrument.
- 9) Press the HOLD key to confirm.
- 10) Carry out calibration of other ranges by repeating steps 6) to 9).
- 11) To quit calibration, turn the function switch back to the OFF position.

Range	Input 1	Input 2	Unit
5nF	0.500	5.000	nF
50nF	5.00	50.00	nF
500nF	50.0	500.0	nF
5 μ F	0.500	5.000	μ F
50 μ F	5.00	50.00	μ F
500 μ F	50.0	500.0	μ F
5mF	0.500	5.000	mF
50mF	5.00	40.00	mF

6. Battery and Fuse Replacement



Be careful not to burn yourself.

- Fuse becomes a high temperature after current measurement, it is dangerous by touching it directly.

When fuse or batteries are replaced after current measurement, please be sure to leave the main unit for 10 minutes for cooling.

- La température du fusible augmente sensiblement après une mesure de courant; il est dangereux de le toucher directement. Après le remplacement du fusible et des piles après une mesure de courant, laissez refroidir l'instrument pendant 10 minutes" ou une annotation équivalente sera reprise dans le manuel d'utilisation.

6.1 Battery Replacement

If the batteries fall below the normal operating voltage, the “” symbol turns on. Follow the steps below to replace the batteries with new ones.

(AA-size (R6) 1.5V batteries)

Set the time by referring to the Set-up function after changing the batteries.

If you remove the batteries, the time resets to 00:00 and the time for LOGGING measurement will not be correct.



Be sure to disconnect the instrument from the circuit under test and test leads before replacing the batteries.



- Turn the function switch to OFF (turn off the power).
- Do not mix batteries of different types or new batteries with used ones.
- Make sure the polarities of the new batteries are exactly as shown on the battery holder.

To replace the batteries:

- 1) Remove the screw on the back of the casing.
- 2) Remove the back cover.
- 3) Take the batteries out of the housing.
- 4) Replace the batteries with new ones.
- 5) Close the casing and fasten it with the screw.

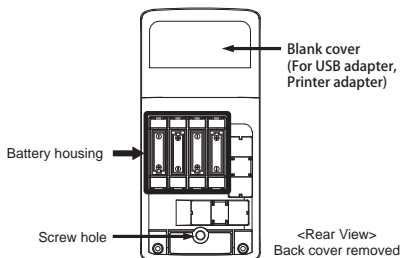

6.2 Fuse Replacement

If a current greater than the rated value flows when the instrument is in the current-measurement range, a protection fuse may blow.

If this happens, replace that fuse. The instrument contains the following types of fuses.



WARNING

- Turn the function switch to OFF(turn off the power).
- Be sure to disconnect the instrument from the circuit under test and test leads before replacing the fuses.
- Do not operate the instrument with the casing left open.
- In order to avoid damage to the instrument or any possible accident, use fuses of the specified rating.

Fuse rating: F1 M-8926 (440mA/1000V, SIBA GmbH & Co. KG, 50 210 06.0.44)

F2 M-8927 (10A/1000V, SIBA GmbH & Co. KG, 50 199 06.10)

High breaking capacity type

To replace the fuse:

- 1) Remove the screw on the back of the casing.
- 2) Remove the back cover.
- 3) Remove the blown fuse from the fuse holder.
- 4) Install a new fuse in the holder.
(Make sure the fuse rating.)
- 5) Close the casing and fasten it with the screw.

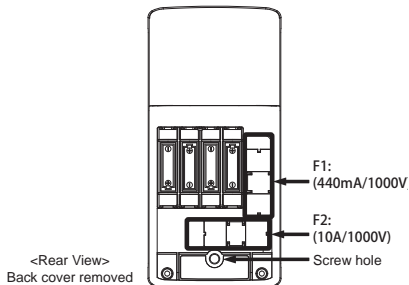

7. Calibration and Maintenance

Calibration Cycle

It is recommended that the instrument be calibrated once every year.
(SEE ALSO: User Calibration Function)

Contacts of Services

Please contact the sales representative from which you purchased the instrument.

8. Disposing the Product

Waste Electrical and Electronic Equipment (WEEE), Directive 2002/96/EC

This Product complies with the WEEE Directive (2002/96/EC) marking requirement.
The affixed product label (see below) indicates that you must not discard this electrical/
electronic product in domestic household waste.

Product Category

With reference to the equipment types in the WEEE directive Annex 1, this product is
classified as a “Monitoring and Control instrumentation” product.



DISTRIBUTOR

Kyoritsu reserves the rights to change specifications or designs described in this manual without notice and without obligations.



KYORITSU ELECTRICAL INSTRUMENTS WORKS, LTD.

2-5-20, Nakane, Meguro-ku,

Tokyo, 152-0031 Japan

Phone: +81-3-3723-0131

Fax: +81-3-3723-0152

Factory: Ehime, Japan

www.kew-ltd.co.jp