

1535/1537/1537-II

Insulation Tester

Users Manual

LIMITED WARRANTY AND LIMITATION OF LIABILITY

The Fluke 1537 will be free from defects in material and workmanship for 3 years from the date of purchase.

The Fluke 1535 will be free from defects in material and workmanship for 1 year from the date of purchase.

The Fluke 1537-II will be free from defects in material and workmanship for 5 years from the date of purchase.

This warranty does not cover fuses, disposable batteries, or damage from accident, neglect, misuse, alteration, contamination, or abnormal conditions of operation or handling. Resellers are not authorized to extend any other warranty on Fluke's behalf. To obtain service during the warranty period, contact your nearest Fluke authorized service center to obtain return authorization information, then send the product to that Service Center with a description of the problem.

THIS WARRANTY IS YOUR ONLY REMEDY. NO OTHER WARRANTIES, SUCH AS FITNESS FOR A PARTICULAR PURPOSE, ARE EXPRESSED OR IMPLIED. FLUKE IS NOT LIABLE FOR ANY SPECIAL, INDIRECT, INCIDENTAL OR CONSEQUENTIAL DAMAGES OR LOSSES, ARISING FROM ANY CAUSE OR THEORY. Since some states or countries do not allow the exclusion or limitation of an implied warranty or of incidental or consequential damages, this limitation of liability may not apply to you.

Fluke Corporation
P.O. Box 9090
Everett, WA 98206
U.S.A.

China Service Center
Rm 101, 1/F, Tong Heng Tower
No. 4 Hua Yuan Road,
Hai Dian District, Beijing
100088, P.R.C.
Hotline: 400 921 0835

Table of Contents

Introduction	1
Contact Fluke	2
Safety Information	2
Unpack the Tester	2
The Tester	3
Pushbuttons	3
Tester On/Off.....	5
Display	6
Guard Terminal Use	7
Insulation Test Settings	9
Preset Test Voltage Selection	9
Program a Test Voltage (1537/1537-II only)	9
Select a Ramp or Steady-State Test (1537/1537-II only).....	10
Set a Timed Test (1537/1537-II only).....	10
Polarization Index (PI).....	11
Dielectric Discharge (1537/1537-II only).....	12
Dielectric Absorption Ratio.....	13
Test Circuit Connections	14
Before an Insulation Test.....	15
Insulation Test	16
Store Test Results (1537/1537-II only).....	19
View Test Results Stored in Memory (1537/1537-II only).....	19
Delete Test Results Stored in Memory (1537/1537-II only)	21
V ac / V dc / Resistance (1537/1537-II only).....	22
1537/1537-II PC Software	24
Maintenance.....	25
Cleaning.....	25
Battery Replacement	25
Product Disposal.....	26
Parts and Accessories.....	26
General Specifications	28
Electrical Specifications	28
Principle of Measurement and Resistance.....	32

Introduction

The Fluke 1535/1537/1537-II Insulation Testers (the Tester or Product) are high-voltage insulation testers to validate general circuits, such as switchgear, motors, and cables.

The Tester features:

- Large liquid crystal display (LCD)
- Preset test voltages: 250 V, 500 V, 1000 V, 2500 V
- Insulation measurement: 200 k Ω to 500 G Ω
- Polarization Index (PI) measurement
- Dielectric Absorption Ratio (DAR) measurement
- Auto power off after 10 minutes of inactivity

The 1537/1537-II also includes:

- V ac/V dc/Resistance measurement
- Programmable test voltages: 250 V to 2500 V in 100 V steps
- Dielectric Discharge (DD) measurement
- Ramp mode that linearly increases (100 V/s) the applied test voltage
- Test timer and storage for test results with user-defined ID tag
- Breakdown voltage indication
- Mini USB serial port for download of test data
- PC software

Contact Fluke

Fluke Corporation operates worldwide. For local contact information, go to our website: www.fluke.com.

To register your product, or to view, print, or download the latest manual or manual supplement, go to our website.

To contact Fluke, call Technical Support China at +86-400-810-3435.

+1-425-446-5500 fluke-info@fluke.com

Safety Information

Make sure to read the Safety Information booklet that shipped with your Product.

Unpack the Tester

The Tester includes these items:

- Insulation Tester (includes batteries)
- Quick Reference Guide
- Safety Information
- Test Cables with Alligator Clips (red, black, green)
- Soft Carrying Case
- Test Report

The 1537/1537-II also includes a USB Cable.

See [Table 8](#) for a list of parts. If the Tester is damaged or an item is missing, contact the place of purchase.

Not all models are available in all regions.

The Tester

Table 1 shows the location of the Tester features.

Table 1. Features



The diagram shows the front panel of the Fluke 1537 Insulation Tester. At the top, there are three input terminals: a red terminal labeled 'E' (Earth), a green terminal labeled 'COM' (Common) with 'G' (Ground) below it, and a red terminal labeled 'L' (Line). Above the terminals, it says 'CAT II 600V' and '30V MAX'. Below the terminals, it says '2500V' and has a warning triangle symbol. The main display is a large LCD screen. Below the screen is a control panel with several buttons: a green power button, a 'FUNCTION' button, a 'TEST' button, a 'TEST VOLTS' button, a 'TIMER CANCEL' button, a 'CLEAR' button, a 'DELETE' button, a set of four arrow keys (up, down, left, right), and a 'MENU ENTER' button. There are also two small circular buttons labeled 'TASC' and 'COMPARE'.

Item	Description
1	LCD
2	USB Port (1537/1537-II only)
3	Input Terminals
4	Pushbuttons



Pushbuttons

Table 2 shows the location of each pushbutton and describes the functions.

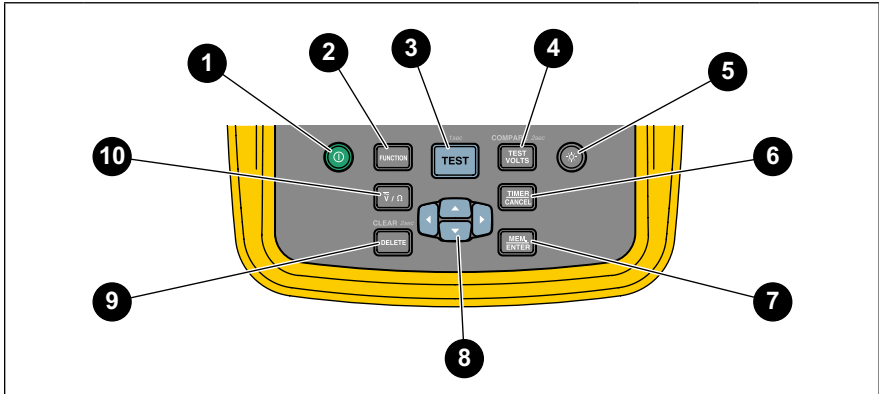
Table 2. Pushbuttons



Item	Description	Model	
		1535	1537/ 1537-II
1	Power On / Power Off	•	•
2	DAR / PI / DAR + PI Selection	•	
	DAR / PI / DAR + PI / DD / Ramp Selection		•
3	Test Start/Stop: Push and hold for 1 s to start a test. Push again to stop a test.	•	•
4	Voltage Setting: 250 V / 500 V / 1000 V / 2500 V	•	•
	Resistance Setting: value comparison		•
5	Backlight On/Off	•	•
6	Test Time Set/Cancel		•
7	Record/Enter		•
8	scrolls through the test results stored in memory for all records.		•
	scrolls through available test parameters for selected function.		
9	Delete Data		•
10	V ac / V dc / Resistance Selection		•

Also use   to access these menu items:

- Voltage adjustment in 100 V for each step
- Time limit xx-xx
- T - 0 to 99 minutes
T1, T2, T3 - $T1 < T2 < T3$
T1 > 0 seconds, T3 < 1000 seconds
- Show test parameters
- Change the name of the ID tag for the test result
- Push  to make the selection.

Tester On/Off

Push  to turn on the Tester.

The Tester does a self-check, shows the software version, and starts in the Insulation Resistance Idle mode.

In Insulation Resistance Idle mode:

- Change test parameters
- Start an insulation test
- View stored test results (1537/1537-II only)
- Download test results (1537/1537-II only)

Caution

If the object under test is highly capacitive, it can take a long time for the Product to discharge. Do not turn off the Product or remove test leads until the discharge is complete.

When on, push  >1 second to turn off the Tester.

Display

Table 3 shows the location of each display feature.

⚠️ ⚠️ Warning

To prevent possible electrical shock, fire, or personal injury:

- Before and after any tests, do a voltage test to confirm that the Tester does not detect the presence of hazardous voltage.
- If the Tester beeps continuously before the insulation test starts and there is hazardous voltage, disconnect test leads and remove power from the circuit under test.

Table 3. Display Features

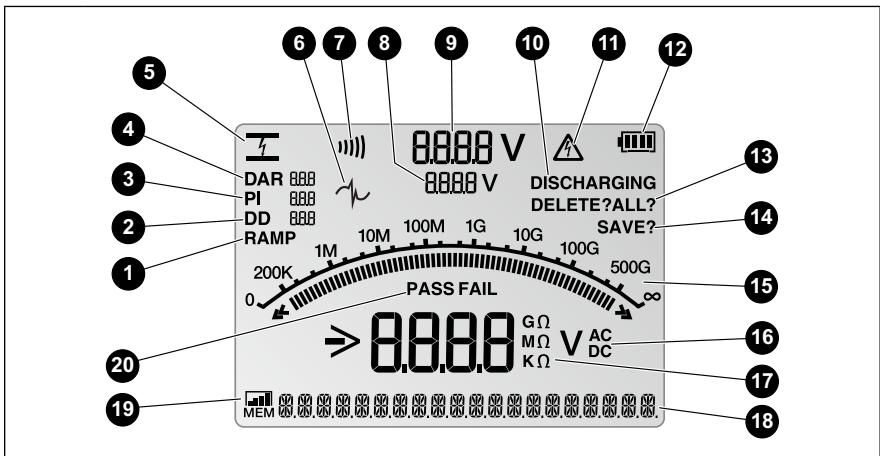

Item	Description
1	Ramp mode
2	Dielectric Discharge
3	Polarization Index
4	Dielectric Absorption Ratio
5	Electrical breakdown in Ramp mode
6	Interference present; readings could be out of specified accuracy range
7	Continuity (1537/1537-II only)
8	Test Voltage Setting
9	Insulation test voltage
10	Discharging

Table 3. Display Features (cont.)

Item	Description
11	Possible hazardous voltage is at the test terminals (L to E and V to COM)
12	Battery Status
13	Delete/Delete All
14	Save
15	Bar graph display of insulation resistance
16	V ac or V dc voltage indicator
17	Insulation and resistance measurement indicator
18	Text display; shows voltage, test current, capacitance, programmable test voltages, and menu options
19	Memory Status
20	Pass/Fail

Guard Terminal Use

Note

Insulation resistance is measured between the Earth terminal (E) and Live terminal (L) output connections. The Guard terminal (G) is at the same potential as the E terminal but is not in the measurement path.

For most tests, use only two test leads. Connect the E and L test leads to the corresponding inputs on the Tester. Connect the test lead probes to the circuit under test. The Guard (G) terminal is left unconnected.

For the best accuracy when you measure very high resistances, use three-wire measurements including G. G is at the same potential as E, and can be used to prevent surface leakage or other unwanted leakage currents from degrading the accuracy of the insulation resistance measurement.

Figure 1 shows how to measure the resistance from one of the conductors to the outer shield. In this case, there is a leakage current along the surface of the inner insulation near the end of the cable. This leakage adds to the current that the negative terminal senses, and causes the Tester to read a lower resistance than it should.

Figure 1. Surface Leakage Current

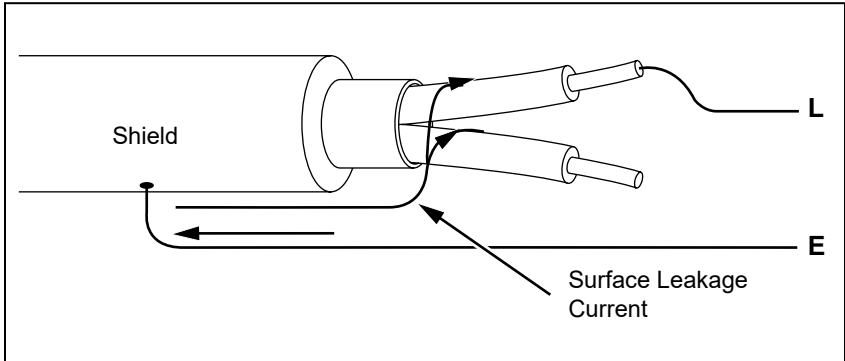

Figure 2 shows how to prevent surface current leakage with a lead connected from the Guard terminal to a conductor that surrounds the inner insulation. The surface leakage current is directed to the Guard terminal. This removes the leakage current from the measurement path between the positive and negative terminals, and improves the accuracy of the test readings.

Figure 2. Guard Terminal Connection

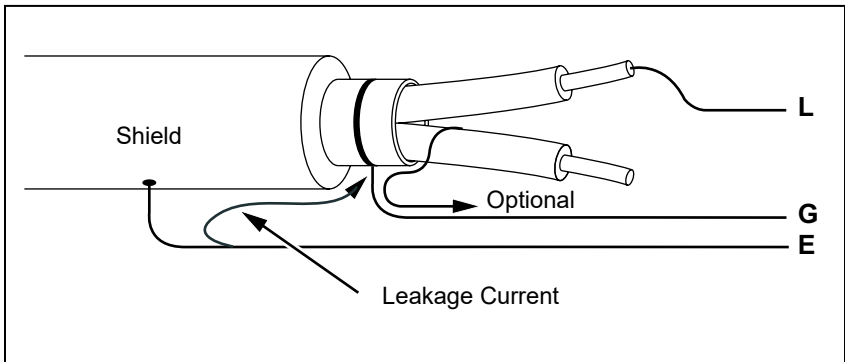
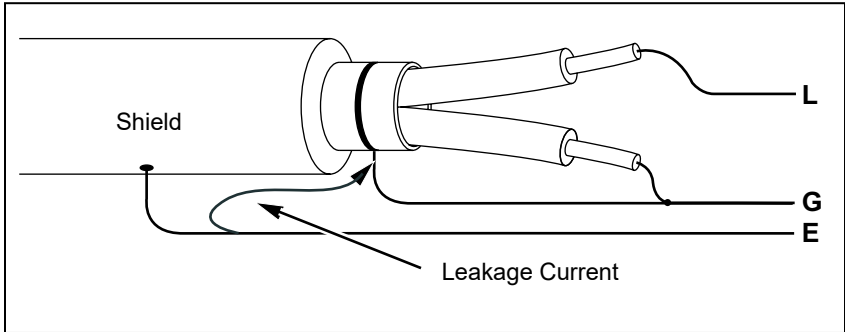

Figure 3 shows how to make the measurement setup better. Connect the Guard terminal to the unused wire and attach it to the inner insulation. This ensures that the Tester measures the leakage between the selected conductor and the outer shield, but removes the leakage path between conductors.

Figure 3. Improved Guard Terminal Connection



Insulation Test Settings

Preset Test Voltage Selection

To make a preset test voltage selection:

1. Turn on the Tester.
2. Push **TEST VOLTS** to scroll through the preset test voltage options (250 V, 500 V, 1000 V, 2500 V).

The test voltage selection shows on the display.

Note

The actual test voltage can be up to 10 % higher than the selected test voltage.

Program a Test Voltage (1537/1537-II only)

To set a test voltage in between the preset test voltages, proceed as follows:

1. Turn on the Tester.
2. Push **TEST VOLTS** to select the test voltage.
3. Continue to push **TEST VOLTS** to scroll through the preset test voltage options (250 V, 500 V, 1000 V, 2500 V). Select the voltage closest to the level required.

The test voltage selection shows on the display.

4. Push **▲** or **▼** to increase and decrease the voltage in 100 V steps until the correct voltage level shows.

Note

The test voltage can be up to 10 % higher than the test voltage you select.

Select a Ramp or Steady-State Test (1537/1537-II only)

The ramp test function is an automated test that checks insulation for a breakdown. During a ramp test, the output voltage starts at 0 V and increases linearly (100 V/s) until it reaches the specified test voltage or until the Tester senses a sudden drop in measured resistance.

If the Tester senses a sudden drop in resistance:

- Ramp stops
- Tester automatically discharges

If the test successfully meets compliance without breakdown, the result is the same as a normal insulation test and shows the data.

To enable or disable the ramp function:

1. With the Tester turned on, push **FUNCTION** to go to the Ramp test function. When the ramp test is on, RAMP shows on the display.

Set a Timed Test (1537/1537-II only)

You can control the duration of an insulation test by setting a timer. The time (test duration) can be set in 1-minute increments up to 99 minutes.

At the end of the elapsed time, the insulation test is complete and the test stops.

To set a test time limit:

1. With the Tester turned on, push **TIMER CANCEL** to enter the Timed Test Menu.
2. Push **▲** or **▼** to configure the time.
3. Push **MEM. ENTER** to set the time limit.

Polarization Index (PI)

As part of the insulation test, the Tester measures and stores polarization index (PI), when appropriate. A polarization index test requires 10 minutes to complete. Therefore, the Tester will start a countdown at 10 minutes. When an insulation test reaches 10 minutes, the polarization test is complete. The results are available for display during a test or when you store the test results and view the record PI field. See [Figure 4](#).

The field is identified by:

$$PI = \frac{R_{10\text{min}}}{R_{1\text{min}}}$$

Figure 4. Polarization Index (PI)

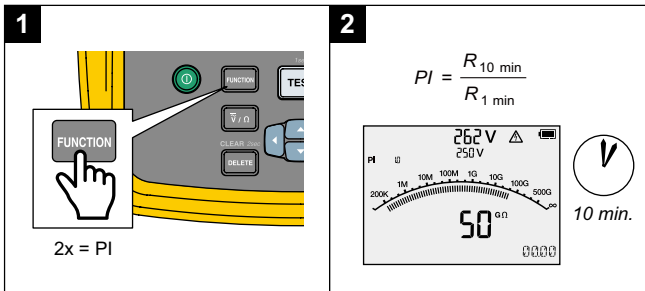

Dielectric Discharge (1537/1537-II only)

The dielectric discharge (DD) test, also known as the re-absorption current test, is a measurement of the current during dielectric discharge of the equipment being tested.

The measurement principle is as follows:

1. Equipment to be tested is first charged for 30 minutes to reach a stable state (capacitance charging and polarization are completed and the only current flowing is the leakage current).
2. Equipment is then discharged through a resistor inside the megaohmmeter and the current that flows is measured. This current is made up of the capacitance charging current and the re-absorption current that combines to give the total dielectric discharge current. This current is measured after a standard time of 1 minute. The current depends on the overall capacitance and the final test voltage. See [Figure 5](#).

The value DD is calculated with this formula:

$$DD = \frac{I}{V \times C}$$

I = current after 1-minute discharge

V = voltage before discharge

C = measured object capacitor

Figure 5. Dielectric Discharge

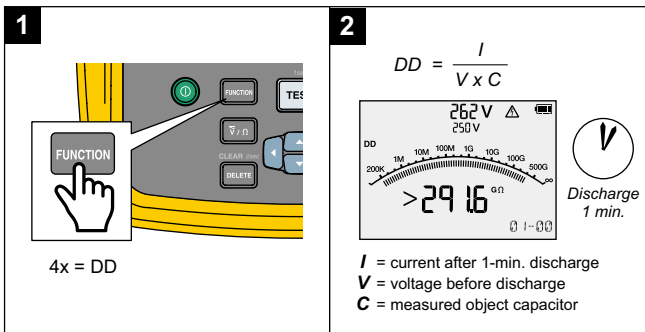

Dielectric Absorption Ratio

If appropriate, as part of the insulation test, the Tester stores the dielectric absorption ratio (DAR) with the measurement. A DAR test has a 1-minute duration and is measured and stored as invalid data for all insulation tests <1 minute. The DAR test automatically stops when the insulation test time reaches 1 minute. The results are available for display after test or by storing the test results and viewing the DAR field in record. See [Figure 6](#).

The field is identified by:

$$DAR = \frac{R_{1min}}{R_{30s}}$$

The Tester also does the DAR test in accordance with the Chinese standards:

$$DAR_{[CN]} = \frac{R_{1min}}{R_{15s}}$$

Note

If appropriate, as part of the insulation test, the Tester stores the capacitance measurement. The results are available for display after the test is complete by viewing the capacitance field in the stored record.

Figure 6. Dielectric Absorption Ratio

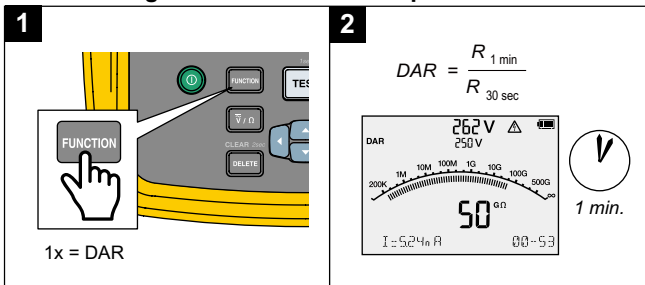

Test Circuit Connections

⚠⚠ Warning

To prevent possible electric shock or personal injury:

- Disconnect power and discharge all high-voltage capacitors before you measure resistance.
- Connect the Earth (E) test lead before the live (L) test lead and remove the L test lead before the E test lead.
- Before and after tests, do a voltage test to confirm that the Tester does not detect the presence of hazardous voltage. See [Table 3](#). If a hazardous voltage is shown on the display, remove power from the circuit under test and disconnect test leads.

To connect to the circuit under test:

1. Put the test leads into the correct terminals. See [Table 4](#).
2. Connect the test leads to the circuit under test.

Table 4. Test Lead Connections

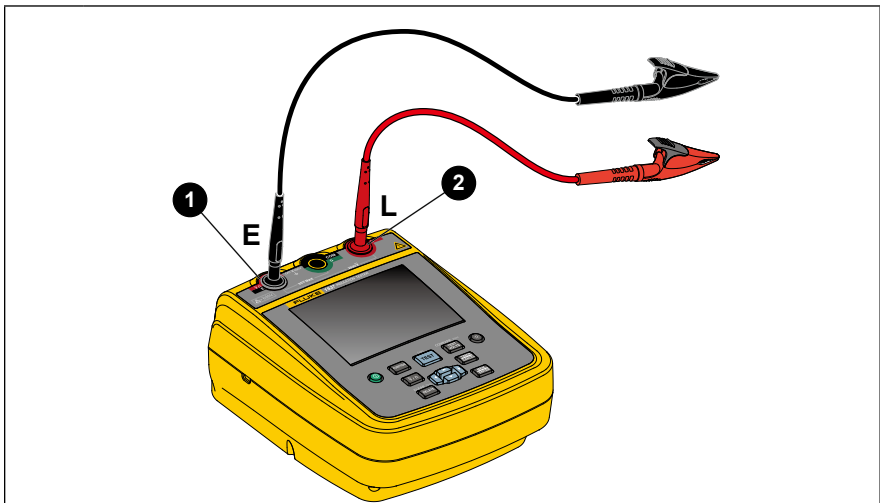

Item	Description
①	E - Earth Terminal
②	L - Live Terminal

Note

The Tester does not have specified accuracy below 200 k Ω . When you do a test below 200 k Ω or with the leads shorted, the Tester can show a reading. This is normal for the input circuitry configuration for this Tester. Only the readings within the specified accuracy range are accurate.

Before an Insulation Test

The Tester includes features that let you adapt the test to your requirements. You can:

- Define a test voltage
- Measure polarization index (PI)
- Measure dielectric absorption ratio (DAR)

1537/1537-II only:

- Make a ramp test selection
- Measure dielectric discharge (DD)
- Compare insulation resistance
- Set a time limit/duration for the test

Use these features alone or in combination. Configure or validate (as appropriate) each feature before you start an insulation test. For connections, see [Figure 7](#).

Figure 7. Insulation Test Connections

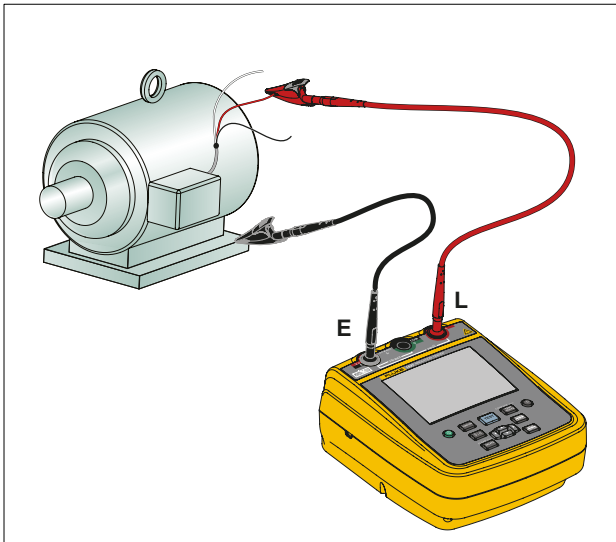

Insulation Test

Warning

To prevent possible electrical shock or personal injury:

- **Be aware that measuring insulation resistance requires the application of potentially dangerous voltages to the circuit. This may include exposed bonded metalwork.**
- **Remove all power from the circuit under test and discharge circuit capacitance before testing a circuit with the Tester.**
- **Before a test starts, ensure that the installation is wired correctly and no personnel are endangered by any tests.**
- **Connect the test leads to the Tester inputs before you make any connections to the circuit under test.**

PI/DAR is valid in these conditions:

- Capacitance is $\leq 0.1 \mu\text{F}$ or Resistance is $\leq 100 \text{ M}\Omega$.
- Resistance is $\geq 200 \text{ k}\Omega$ and Capacitance $\leq 2 \mu\text{F}$.
- Current is $\geq 50 \text{ nA}$.

To do an insulation test:

1. With the Tester turned on, set the available measurement options to meet your test requirements. These include:
 - Test Voltage – Set range: 250 V to 2500 V (1537/1537-II only: 100 V steps)
 - Ramp Test – (optional, 1537/1537-II only)
 - Time Limit – (optional, 1537/1537-II only)
2. Connect the probes to the circuit under test, see [Figure 7](#).

⚠⚠ Warning

To prevent possible electric shock or personal injury:

- Before and after tests, do a voltage test to confirm that the Tester does not detect the presence of hazardous voltage. See [Table 3](#).
- If the Tester beeps continuously before the insulation test starts and there is hazardous voltage, disconnect test leads and remove power from the circuit under test.

3. Push **TEST VOLTS** to select 250 V, 500 V, 1000 V, or 2500 V.

4. Push **TEST** for 1 second to start the insulation test.

The Tester makes three beeps as the test begins, and **⚠** flashes on the display to indicate potentially hazardous voltages may be present on the test terminals.

The display shows the insulation resistance after the circuit stabilizes. The bar graph shows this value continuously (in real time) as a trend. See [Table 5](#).

Table 5. Insulation Resistance Measurements

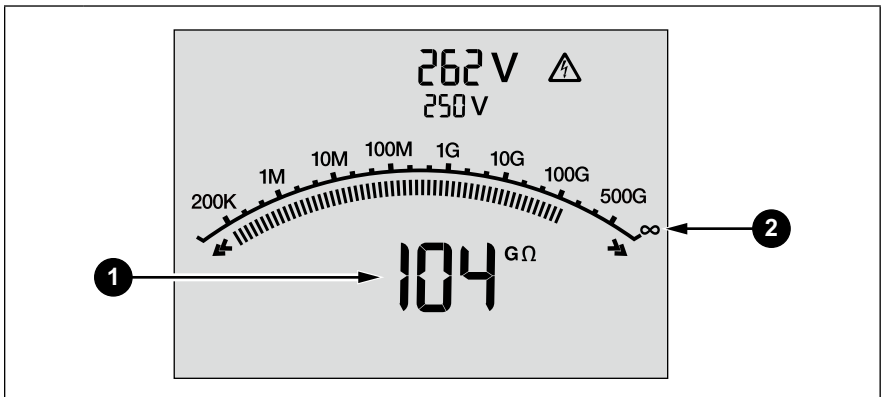

Item	Description
1	Digital main display
2	Bar graph

Any of the following conditions will stop an insulation test:

- User stops the test (push **TEST**)
- Time limit is complete (1537/1537-II only)
- Interference on the test circuit
- Breakdown occurs with ramp test enabled (1537/1537-II only)
- DAR / PI / DD reaches time limit
- Battery is depleted

When the insulation test is done, the Tester beeps if a potentially hazardous voltage remains on the test terminals due to charged-circuit capacitance or from the presence of an external voltage.

5. When the test is done, the Tester shows a prompt to store the results. If appropriate, store the test results (see next section). Otherwise, push **TIMER CANCEL** to bypass the prompt. The results are not stored.



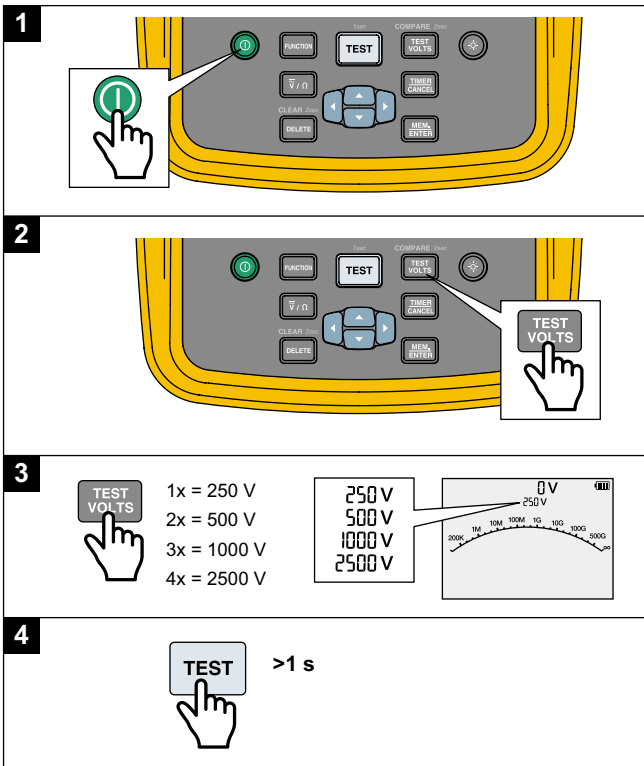



Figure 8. Insulation Test



Store Test Results (1537/1537-II only)

When the insulation test is done, the Tester shows a prompt to save the results. The Tester memory stores the results of up to 99 insulation tests.

To store the results of an insulation test:

1. Push  to save the measurement results. The Tester assigns and displays a sequential tag number to identify the measurement.
2. If the tag number is acceptable, push  to store the data. If a different tag convention is required, create a custom 4-character tag:
 - a. Notice that the active character is blinking on the display. This is the first of the four characters available for tagging the test results. Repeatedly push  to cycle through the character positions.
 - b. At each character position use  or  to assign a character (0-9, A-Z, a-z).
 - c. Push  to store the results.

View Test Results Stored in Memory (1537/1537-II only)

Note

*Parameters not appropriate for a test are shown as **NA** or **UNSPEC**.*

The Tester can store 99 sets of test data, including:

- Tags
- Ramp on or off
- Insulation Resistance
- Timer reading at termination of test (Timer)
- Test Voltage Selected (TV)
- Actual Test voltage (V)
- Capacitance (C)
- Polarization Index (PI)
- Dielectric absorption ratio (DAR)
- Dielectric discharge (DD)
- T1, T2, T3 (time, voltage, current and resistance.)
- Test current (I)
- Reason for ending the test
- Limit – off or timer setting (1 to 99 minutes) (T. Limit)

To view stored test data:

1. With the Tester turned on, push **MEM. ENTER** to view stored records.
2. Push **◀** or **▶** to select Record.
3. Push **▲** or **▼** to view the record detail.

Note

When a voltage is present at the terminals, that voltage is always shown on the top-center of the display, regardless of whether that voltage is sourced by the Tester or is from the circuit under test. See [Table 6](#).

Table 6. View Stored Results

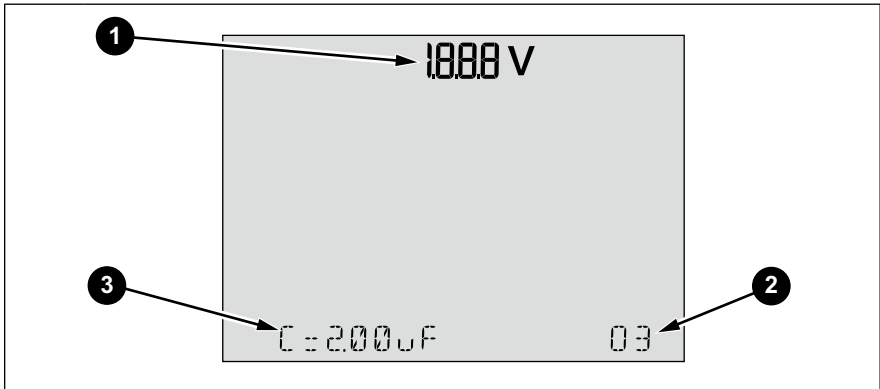





Item	Description
①	Terminal voltage between L and E
②	Stored record label (tag)
③	Stored test results

4. Push **◀** or **▶** to step through the stored locations.
5. Stop at the location you want to view.
6. Push **▲** or **▼** to view the stored test data for a specific test. Test data appears on the alphanumeric text display and on the LCD.





Delete Test Results Stored in Memory (1537/1537-II only)

You can delete a selected test result or delete all stored test results.

To delete a selected test result:

1. Push  to view stored records.
2. Push  to select Record.
3. With the record selected, push . The displays shows the blinking message: DELETE?
4. Push  to delete the current record or push  to cancel.

To delete all test results:

1. Push  to view stored records.
2. Push  >2 seconds. The displays shows the blinking message: DELETE ALL?
3. Push  to delete all records or push  to cancel.

V ac / V dc / Resistance (1537/1537-II only)

The 1537/1537-II includes V ac / V dc and resistance measurement functions.

To do a V ac / V dc or resistance test, see [Figure 9](#):

1. Turn on the Tester.
2. Push \tilde{V}/Ω to select the V ac / V dc or resistance function.
3. Insert the test leads into the correct terminals. See [Table 7](#).
4. Connect the test leads to the circuit under test.
The test result appears on the Tester when the test is complete.

Note

The Tester does not support test result records for the V ac / V dc / Resistance measurements.

The Tester alarm beeps if the resistance measurement is $\leq 30 \Omega$.

Table 7. Connections for V ac / V dc / Resistance Tests

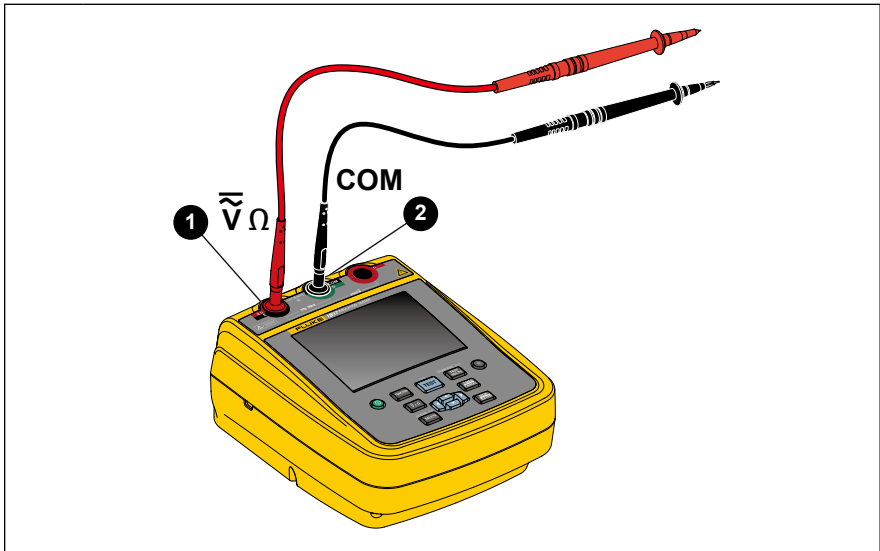

Item	Description
①	V ac / V dc / Resistance
②	COM

Figure 9. V ac / V dc / Resistance

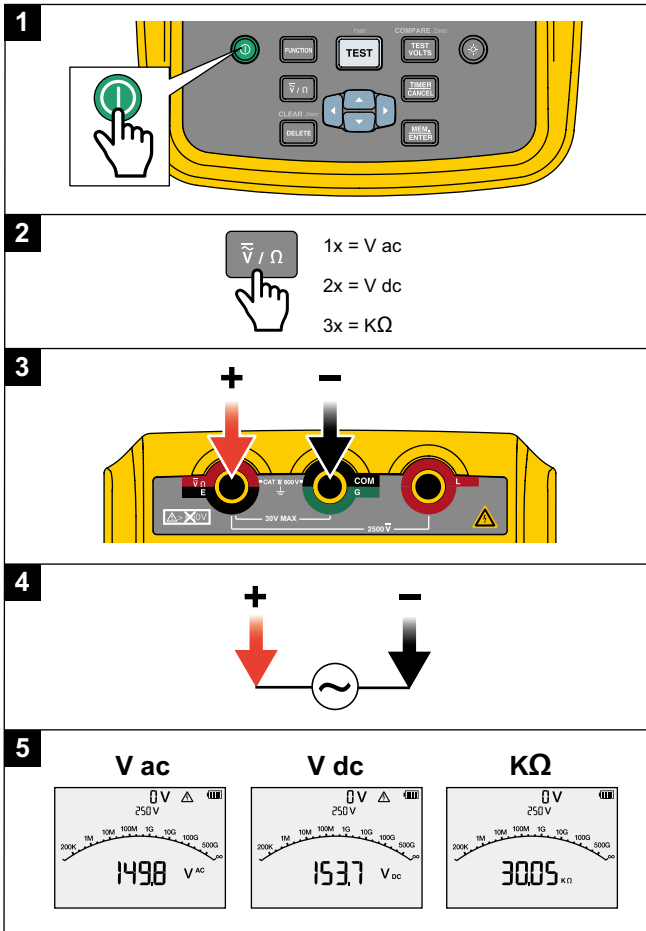

1537/1537-II PC Software

Fluke provides software that lets you download test results from the 1537/1537-II Tester through the USB port, see [Figure 10](#).

Before you can download stored test data from the Tester, you must download the appropriate software from the Fluke website to your PC. After the download completes, follow the software prompts to install the software.

- Install the software drivers on the Windows PC before you use the USB cable.
- Do not use the test functions during communication with the PC.
- Verify that the download is successful before deleting the stored test results on the Tester.
- You can use the Fluke 1537/1537-II PC Software to clear results data stored in the Tester from the PC.

Figure 10. USB Connection

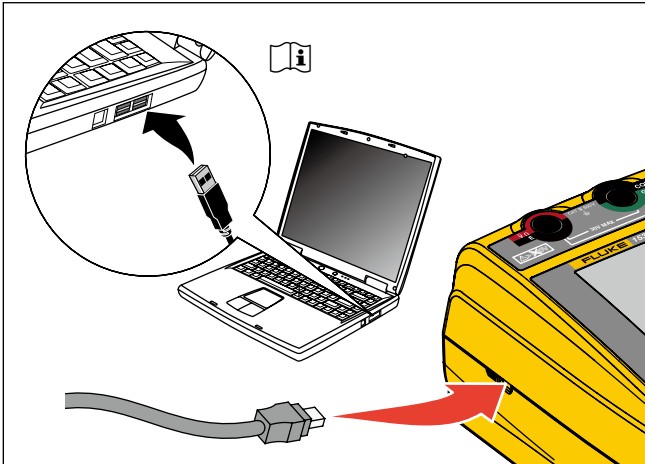

Maintenance

There are no user-replaceable parts inside the Tester.

Warning

To prevent possible electrical shock or personal injury:

- Do not repair or service the Product beyond what is described in this manual.
- Have an approved technician repair the Product.

Cleaning

Periodically wipe the case with a damp cloth and mild detergent. Do not use abrasives or solvents to clean the Tester.

Battery Replacement

To replace the batteries:



1. Turn off the Product and remove all test leads.
2. Turn the battery-door latch until the unlock symbol () aligns with the slot. See [Figure 11](#).
3. Lift off the battery door.
4. Remove the AA batteries and replace with new batteries. Use the correct battery orientation.
5. Install the battery door.
6. Turn the battery-door latch until the slot is vertical to the unlock symbol ()

Figure 11. Battery Replacement



Product Disposal

Dispose of the Product in a professional and environmentally sound manner:

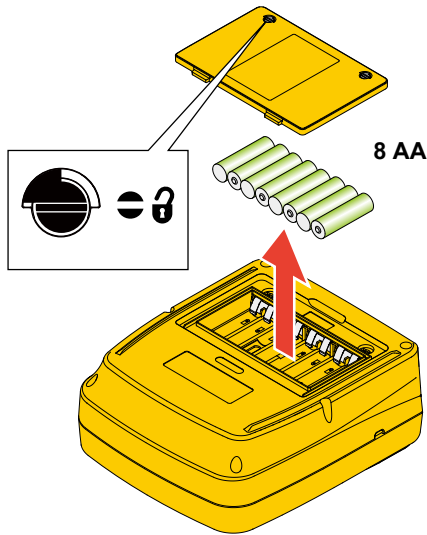
- Delete personal data on the Product before disposal.
- Remove batteries that are not integrated into the electrical system before disposal and dispose of batteries separately.
- If this Product has an integral battery, put the entire Product in the electrical waste.

Parts and Accessories

Table 8 is a list of the replaceable parts available for the Tester. Table 9 is a list of the accessories available for use with the Tester.

Table 8. Replacement Parts

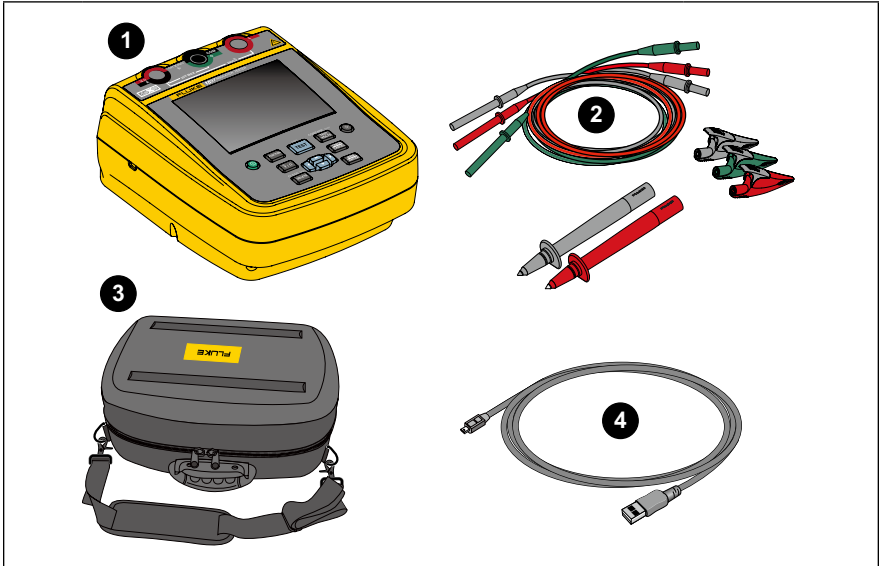

Item	Description	Part No.
1	Insulation Tester: 1535/CN	4877761
	Insulation Tester: 1537/CN	4877777
	Insulation Tester: 1537-II/CN	5575480
	Insulation Tester: 1535/APAC	5304189
	Insulation Tester: 1537/APAC	5304192
	Insulation Tester: 1535	5592398
	Insulation Tester: 1537	5592405
2	Test Lead set, 5 kV Banana Plug, Red/Black/Green	3403917
	Test Probe, Banana Jack, 4 mm Tip, Red	2099044
	Test Probe, Banana Jack, 4 mm Tip, Black	2427138
	Alligator Clip – Red	2041727
	Alligator Clip – Black	2041730
	Alligator Clip – Green	2068133
3	Soft Carrying Case	4862393
4	USB Cable (1537/1537-II only)	4499448

Table 9. Accessories

Accessory	Part No.
10 kV Clamp (Red/Black/Green)	4103525

Table 10. Number of Insulation Resistance Measurements

Un (V)	R _{load} (Ω)	Number of Measurements
250 V	250 kΩ	6500
500 V	500 kΩ	3800
1000 V	1 MΩ	2200
2500 V	2.5 MΩ	1300

General Specifications

For a list of specifications for 1535/1537, please refer to the *1535/1537 Insulation Tester Safety Information*.

Electrical Specifications

The Tester's accuracy is specified for 1 year after calibration at operating temperatures of 10 °C to 30 °C. For operating temperatures outside the range (-10 °C to +10 °C and +30 °C to +50 °C), add ±0.25 % per °C for 5 % bands and add ±1 % per °C for 20 % bands.

Table 11. Insulation Resistance Measurement

Test Voltage	Range	Resolution	Accuracy
250 V	<200 kΩ	unspecified	unspecified
	200 kΩ to 500 kΩ	1 kΩ	5 %
	0.50 MΩ to 5.00 MΩ	0.01 MΩ	5 %
	5.0 MΩ to 50.0 MΩ	0.1 MΩ	5 %
	50 MΩ to 500 MΩ	1 MΩ	5 %
	0.50 GΩ to 5.00 GΩ	0.01 GΩ	5 %
	5.0 GΩ to 50.0 GΩ	0.1 GΩ	20 %
	>50 GΩ	unspecified	unspecified

Table 11. Insulation Resistance Measurement (cont.)

Test Voltage	Range	Resolution	Accuracy
500 V	<200 kΩ	unspecified	unspecified
	200 kΩ to 500 kΩ	1 kΩ	5 %
	0.50 MΩ to 5.00 MΩ	0.01 MΩ	5 %
	5.0 MΩ to 50.0 MΩ	0.1 MΩ	5 %
	50 MΩ to 500 MΩ	1 MΩ	5 %
	0.50 GΩ to 5.00 GΩ	0.01 GΩ	5 %
	5.0 GΩ to 10.0 GΩ	0.1 GΩ	5 %
	10.0 GΩ to 50.0 GΩ	0.5 GΩ	20 %
	50 GΩ to 100 GΩ	5 GΩ	20 %
	>100 GΩ	unspecified	unspecified
1000 V	<200 kΩ	unspecified	unspecified
	200 kΩ to 500 kΩ	1 kΩ	5 %
	0.50 MΩ to 5.00 MΩ	0.01 MΩ	5 %
	5.0 MΩ to 50.0 MΩ	0.1 MΩ	5 %
	50 MΩ to 500 MΩ	1 MΩ	5 %
	0.50 GΩ to 5.00 GΩ	0.01 GΩ	5 %
	5.0 GΩ to 20.0 GΩ	0.1 GΩ	5 %
	20.0 GΩ to 50.0 GΩ	0.5 GΩ	20 %
	50 GΩ to 200 GΩ	5 GΩ	20 %
	>200 GΩ	unspecified	unspecified

Table 11. Insulation Resistance Measurement (cont.)

Test Voltage	Range	Resolution	Accuracy
2500 V	<200 k Ω	unspecified	unspecified
	200 k Ω to 500 k Ω	1 k Ω	5 %
	0.50 M Ω to 5.00 M Ω	0.01 M Ω	5 %
	5.0 M Ω to 50.0 M Ω	0.1 M Ω	5 %
	50 M Ω to 500 M Ω	1 M Ω	5 %
	0.50 G Ω to 5.00 G Ω	0.01 G Ω	5 %
	5.0 G Ω to 50.0 G Ω	0.1 G Ω	5 %
	50 G Ω to 500 G Ω	5 G Ω	20 %
	>500 G Ω	unspecified	unspecified

Bar graph range: 0 Ω to 500 G Ω
 Insulation test voltage accuracy: -0 %, +10 % at 1 mA load current
 Charging rate for capacitive load: 5 s/ μ F
 Discharge rate for capacitive load: 1.5 s/ μ F

	Range	Accuracy
Leakage Current Measurement	1 nA to 2 mA	$\pm(20 \% + 2 \text{ nA})$
Capacitive Measurement	0.01 μ F to 2.00 μ F	$\pm(15 \% \text{ of reading} + 0.03 \mu\text{F})$
Insulation Resistance Test Voltage	250 V to 2500 V	$\pm(3 \% + 3 \text{ V})$

	Range	Resolution
Timer	0 to 99 minutes	Setting: 1 minute Indication: 1 second

Warning Range	
Live circuit warning	>30 V

Short circuit current	
1535	>2 mA
1537	>5 mA

Table 12. V ac / V dc / Resistance Measurement (1537/1537-II Only)

Function	Range	Resolution	Accuracy ±(% reading + Digits)
V ac	0 V to 600.0 V	0.1 V	±(2 % +10) (45 Hz to 500 Hz)
V dc	0 V to 600.0 V	0.1 V	±(2 % +10)
Resistance	0 Ω to 600.0 Ω	0.1 Ω	±(2 % +10)
	600 Ω to 6000 Ω	1 Ω	
	6.00 kΩ to 60.00 kΩ	0.01 kΩ	

Table 13. Operating Ranges and Uncertainties per EN 61557

Function	Display Range	EN 61557 Measurement Range Operating Uncertainty ±(% reading + Digits)	Nominal Values
V EN 61557- 1 ^[1]	0 V ac to 600 V ac 45 Hz to 500 Hz	0 V ac to 600 V ac ±(2 % +10 digits)	UN = 230/400 V ac f = 50/60 Hz
RISO EN 61557-2	0 kΩ to 500 GΩ	200 kΩ to 500 GΩ ±20 %	UN = 250 / 500 / 1000 / 2500 V dc IN = 1.0 mA
^[1] 1537/1537-II only			

Table 14. Operating Uncertainties per EN 61557

Parameter	Specification	Typical	Max ^[1]
Intrinsic uncertainty	IEC 61557-2 A, Reference conditions	1.63 %	3.68 %
Position	IEC 61557-2 E1, Reference Conditions ±90 °	2.29 %	5.00 %
Supply Voltage	IEC 61557-2 E2, At low battery voltage stated by manufacture	2.80 %	6.09 %
Temperature	IEC 61557-2 E3, -10 °C and 50 °C	3.36 %	9.83 %
Operating Uncertainty	IEC 61557-2 B, ≤30 %	7.30 %	18.17 %
^[1] Confidence level: 95 %			

Principle of Measurement and Resistance

The Tester uses these formulas to measure insulation parameters and display the results:

Ohm's Law	$R = \frac{V}{I}$
Capacitance (Charge)	$C = \frac{Q}{V}$
PI (Polarization Index)	$PI = \frac{R_{10\min}}{R_{1\min}}$
DAR (Dielectric Absorption Ratio)	$DAR_{[CN]} = \frac{R_{1\min}}{R_{15s}} \quad DAR = \frac{R_{1\min}}{R_{30s}}$
DD (Dielectric Discharge)	$DD = \frac{I}{V \times C}$ <p>I = current after 1-minute discharge V = voltage before discharge C = measured object capacitor</p>