

INSTRUCTION MANUAL

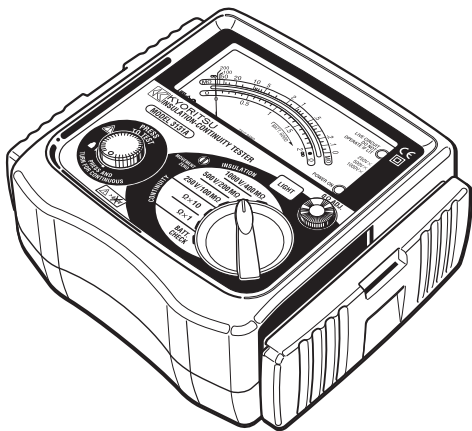

ANALOGUE INSULATION/CONTINUITY TESTER

MODEL 3131A

**KYORITSU ELECTRICAL INSTRUMENTS
WORKS, LTD., TOKYO JAPAN**

Contents

1. Safety Warnings	1
2. Features	5
3. Specifications	6
4. Instrument Layout	8
5. Preparation for Testing.....	10
5-1 Removing the Cover	10
5-2 Mechanical Zero Adjustment	11
5-3 Battery Voltage Check	11
5-4 Test Probe Connection	11
5-5 Test Probe Check	11
6. Operation	12
6-1 Disconnection and Check of Power Source of Circuit Under Test	12
6-2 Insulation Resistance Measurement	13
6-3 Continuity Testing (Resistance Tests)	14
6-4 Continuous Measurement	15
7. Back Light Function	16
8. Battery & Fuse Replacement	17
8-1 Battery Replacement	17
8-2 Fuse Replacement	17
9. Notes on Accessories	18
9-1 How to Fit Strap Belt & Test Probe Pouch	18
10. Cleaning of the Instrument	19
11. Service	19

1. SAFETY WARNINGS

This instrument has been designed, manufactured and tested according to IEC 61010: Safety requirements for Electronic measuring apparatus, and delivered in the best condition after passed the inspection. This instruction manual contains warnings and safety rules which must be observed by the user to ensure safe operation of the instrument and retain it in safe condition. Therefore, read through these operating instructions before using the instrument.

 **WARNING**

- Read through and understand the instructions contained in this manual before using the instrument.
- Keep the manual at hand to enable quick reference whenever necessary.
- The instrument is to be used only in its intended applications.
- Understand and follow all the safety instructions contained in the manual.

It is essential that the above instructions are adhered to. Failure to follow the above instructions may cause injury, instrument damage and/or damage to equipment under test. Kyoritsu is by no means liable for any damage resulting from the instrument in contradiction to these cautionary notes.







- The symbol  indicated on the instrument, means that the user must refer to the related parts in the manual for safe operation of the instrument. It is essential to read the instructions wherever the symbol appears in the manual.

 **DANGER** : is reserved for conditions and actions that are likely to cause serious or fatal injury.

 **WARNING** : is reserved for conditions and actions that can cause serious or fatal injury.

 **CAUTION** : is reserved for conditions and actions that can cause injury or instrument damage.

Please refer to following explanation of the symbols used on the instrument and in this manual.

	User must refer to the explanations in the instruction manual.
	Caution, risk of electric shock.
	Instrument with double or reinforced.
	Protection against wrong connection is up to 440V.
	EARTH GROUND
	This instrument satisfies the marking requirement defined in the WEEE Directive 2002/96/EC. This symbol indicates separate collection for electrical and electronic equipment.

DANGER

- Confirm a proper operation of the instrument with a well-known power supply.
- Do not use this instrument on energized (LIVE) circuits.
- Do not attempt to make measurement in the presence of flammable gasses. Otherwise, the use of the instrument may cause sparking, which can lead to an explosion.
- Do not make measurement when thunder is rumbling. If the instrument is in use, stop the measurement immediately and remove the instrument from the measured object.
- Never attempt to use the instrument if its surface or your hand is wet.
- Never open the battery compartment cover and the instrument case when making a measurement.
- Do not exceed the maximum allowable input of measuring ranges.
- The instrument is to be used, only in its intended applications or conditions. Otherwise, safety functions equipped with the instrument doesn't work, and instrument damage or serious personal injury may be caused.
- Always Keep your fingers and hands behind the protective fingerguard on test probe to avoid the possible shock hazard.

 **WARNING**

- Never attempt to make any measurement, if the instrument has any structural abnormality such as cracked case or exposed metal parts.
- Do not turn the range selector switch while the test probe are connected to the circuit under test.
- Do not install substitute parts or perform any unauthorized modification of the instrument. Return the instrument to Kyoritsu or your distributor for service and repair to ensure the safety features are maintained.
- Do not try to replace the batteries and fuse if the surface of the instrument is wet.
- Firmly insert the plug into the terminal when using test probe.
- Make sure to disconnect the test probe from the instrument before opening the battery compartment cover for battery and fuse replacement.
- Stop using the test lead if the outer jacket is damaged and the inner metal or color jacket is exposed.

 **CAUTION**

- Always make sure to set the range selector switch to the appropriate position before making measurements.
- Do not expose the instrument to the direct sun, dew fall or extreme temperature and humidity.
- When the instrument will not be in use for a long period of time, place it in storage after removing batteries.
- Use a damp cloth soaked in water or neutral detergent for cleaning the instrument. Do not use abrasives or solvents.
- Keep your fingers and hands behind the protective fingerguard during measurement.

Measurement categories (Over-voltage categories)

To ensure safe operation of measuring instruments, IEC 61010 establishes safety standards for various electrical environments, categorized as O to CAT IV, and called measurement categories.

Higher-numbered categories correspond to electrical environments with greater momentary energy, so a measuring instrument designed for CAT III environments can endure greater momentary energy than one designed for CAT II.

- O : Circuits which are not directly connected to the mains power supply.
- CAT II : Primary electrical circuits of equipment connected to an AC electrical outlet by a power cord.
- CAT III : Primary electrical circuits of the equipment connected directly to the distribution panel, and feeders from the distribution panel to outlets.
- CAT IV : The circuit from the service drop to the service entrance, and to the power meter and primary overcurrent protection device (distribution panel).

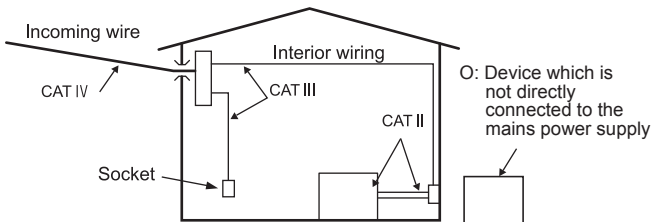

2. Features

MODEL-3131A is an analogue insulation tester with five ranges for insulation resistance measurement and continuity testing (resistance tests) of low voltage installations.

- Designed to safety standards:
 - IEC61010-1
 - IEC61010-031
 - IEC 61557-1,2,4,10
- Dust and drip proof construction to IP54
- Three insulation test ranges : 250V/100M Ω , 500V/200M Ω , 1000V/400M Ω
- Two continuity test ranges : 2 Ω , 20 Ω
- Back light function to facilitate work at night or dimly lit locations
- Easy for battery check
- Power-on indication LED lighting during battery check and measurement
- Live circuit warning indication with LED lighting and the buzzer sound
- Fuse protected.
- Color coded scales and range switch position for easy reading
- Uses only 6 \times 1.5V battery type R6, AA or equivalent

3. Specifications

● **Measuring Range and Accuracy** (at 23±5°C, relative humidity 45-75%)

Insulation Resistance Ranges:(IEC 61557-2)

Nominal Output Voltage	250V	500V	1000V
Measuring Ranges	0 - 100MΩ	0 - 200MΩ	0 - 400MΩ
Open-Circuit Voltage	250V DC +20% max.	500V DC +20% max.	1000V DC + 20% max.
Short-Circuit Current	1.3mA approx		
Nominal Current	1mA DC min. at 0.25MΩ	1mA DC min. at 0.5MΩ	1mA DC min. at 1MΩ
Accuracy	±5% of indicated value at 0.1MΩ- 10MΩ	±5% of indicated value at 0.2MΩ- 20MΩ	±5% of indicated value at 0.4MΩ- 40MΩ
	±0.7% of scale length at ranges other than above ranges		

Continuity Test (Resistance Test) Ranges:(IEC 61557-4)

Ranges	x 1 Ω	x 10 Ω
Measuring Ranges	0 - 2 Ω	0 - 20 Ω
Open-Circuit Voltage	4 - 9V DC	
Measuring Current	200mA DC min.	
Accuracy	±3% of scale length	
Zero Adjustment Range	0.2 Ω min.	

Operating instrument uncertainty

Insulation Resistance Ranges(IEC 61557-2)

Ranges	Measuring range to keep operating instrument uncertainty	Maximum percentage operating instrument uncertainty
250V/100MΩ	0.1MΩ - 10MΩ	±30%
500V/200MΩ	0.2MΩ - 20MΩ	
1000V/400MΩ	0.4MΩ - 40MΩ	

Continuity Test (Resistance Test) Ranges(IEC 61557-4)

Ranges	Measuring range to keep operating instrument uncertainty	Maximum percentage operating instrument uncertainty
x1 Ω	0.2 Ω - 2 Ω	±30%
x10 Ω	2 Ω - 20 Ω	

The influencing variations used for calculating the operating instrumental uncertainty are denoted as follows:

- Temperature : 0°C and 35°C
- Supply voltage : 6.5V to 10.4V
- Position : Reference position ±90°

※Prior to measurement, apply Zero Adjustment at each position

Typical Number of Measurements (central tendency for supply voltage up to 6.5V)

Insulation Resistance Ranges:	
1000V/400M Ω Range	Approx. 500 times min.
500V/200M Ω Range	Approx. 1300 times min.
250V/100M Ω Range	Approx. 1800 times min.
Continuity Test (Resistance Test) Ranges:	
x1 Ω Range/ x 10 Ω Range	Approx. 1000 times min.

Applicable Standards

IEC 61010-1. -2-030	Measurement CAT III 300V Pollution Degree 2
IEC 61010-031	Safety requirements for hand-held probe assemblies
IEC 61557-1,2,4	Measuring equipment for low voltage distribution systems
IEC 61326-2-2	EMC
IEC 60529 (IP54)	Dust & drip proof
EN 50581 (RoHS)	

Used location altitude 2000m or less

Operating Temperature & Humidity: 0-40°C, relative humidity up to 85%

Storage Temperature & Humidity: -20-60°C, relative humidity up to 85%

Insulation Resistance More than 50M Ω at 1000V DC between electrical circuit and housing case

Withstand Voltage 3470V AC for five seconds between electrical circuit and housing case

Overload Protection

Insulation resistance ranges:	1000V Range	1200V (DC) for 10 seconds
	500V Range	600V (DC) for 10 seconds
	250V Range	300V (DC) for 10 seconds
Continuity ranges:	x 1 Ω /x 10 Ω Range	440V (AC p-p) for 1minute

Dimensions: 185(L) x 167(W) x 89(D) mm approx.

Weight: 860g approx. (including batteries)

Power Source: 6 x 1.5V battery type SUM-3, R6, AA or equivalent

Accessories	Test Probe MODEL7122B	x 1 set
	Strap belt	x 1
	Test probe pouch	x 1
	R6P AA batteries	x 6
	Spare fuse F 500mA/600V	x 1
	Instruction manual	x 1

4. Instrument Layout

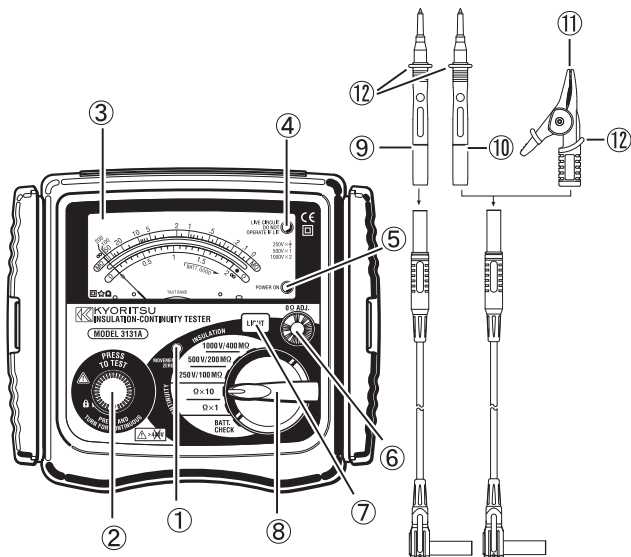
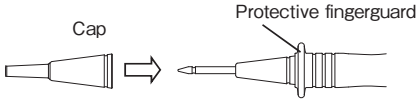

Fig.1 Part names

- | | |
|-------------------------------|----------------------------------|
| ① METER MOVEMENT ZERO ADJUST | ② TEST BUTTON |
| ③ SCALE PLATE | ④ LIVE CIRCUIT WARNING LED |
| ⑤ POWER-ON INDICATION LED | ⑥ CONTINUITY ZERO ADJUST |
| ⑦ LIGHT SWITCH | ⑧ RANGE SELECTOR SWITCH |
| ⑨ TEST PROBE (RED) LINE PROBE | ⑩ TEST PROBE (BLACK) EARTH PROBE |
| ⑪ ALLIGATOR CLIP (BLACK) | ⑫ PROTECTIVE FIGERGUARD |



Protective fingerguard :

It is a part providing protection against electrical shock and ensuring the minimum required air and creepage distances.

Cap :

Uncapped condition for CAT.II environment

Capped condition for CAT.III/ IV environments

The Cap should be firmly attached to the probes.

5. Preparation for Testing

5-1 Removing the Cover

Model 3131A has a dedicated cover to protect against an impact from the outside and prevent the operation part, and the connector socket from becoming dirty.

Remove the cover and put it on the back side of the main body to make measurements.

5-1-1 Method of removing the cover

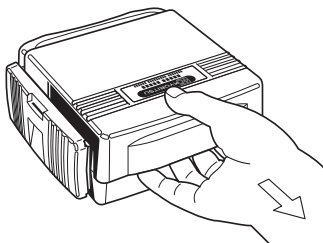

Fig.2

5-1-2 Method of housing the cover

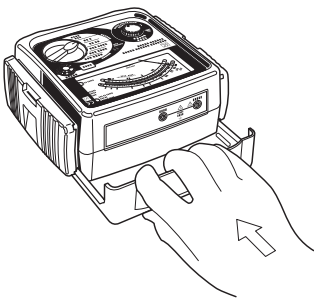

Fig.3

5-2 Mechanical Zero Adjustment

Check that the pointer lines up with the middle of the mark on the scale correctly. If not, adjust it by rotating the meter movement zero adjust with a screwdriver, etc.

5-3 Battery Voltage Check

- ① Set the range selector switch to BATT. CHECK position.
- ② Press the test button.
- ③ Then the pointer deflects. Judge the battery status with BATT.GOOD mark on the scale plate.

If the pointer does not move to BATT.GOOD mark, the batteries are exhausted. Replace them with new batteries according to section 8 for battery & fuse replacement.

5-4 Test Probe Connection

Insert the test probe fully into the terminal of the instrument.

Connect the earth clip of the test probe (black) to EARTH terminal and the line probe (red) to LINE terminal of the connector terminal.

5-5 Test Probe Check

Set the range selector switch to $\times 1 \Omega$ position and press and turn the Test button to lock it down. When the test probe are connected together, the pointer should move from the ∞ position towards the 0 position on the blue continuity scale. If not, the probe or fuse may be faulty. Release the Test button after completion.



CAUTION

Do not keep the test button pressed or locked by turning it clockwise during battery check.

6. Operation

6-1 Disconnection and check of power source of circuit under test

⚠ DANGER

- To avoid possible electrical shock, do not perform measurements on energized (LIVE) circuits.
- Never make measurements with the battery compartment cover removed.
- Always Keep your fingers and hands behind the protective fingerguard on test probe to avoid the possible shock hazard.

⚠ CAUTION

- Never press the test button if the live circuit warning LED is lit or the warning buzzer sounds. This may damage the circuit.

Voltage check can be made with the range selector switch at any position. Be sure to turn off the breaker for the circuit under test.

- ① Connect the earth clip of the test probe (black) to the earth side and the line probe (red) to the line side of the circuit under test.
- ② Ensure that the live circuit warning LED is not lit and the audible warning is not present. If the LED is lit and the buzzer sounds, never press the test button. Voltage is generated in the circuit under test. Recheck that the breaker for the circuit under test is "OFF".

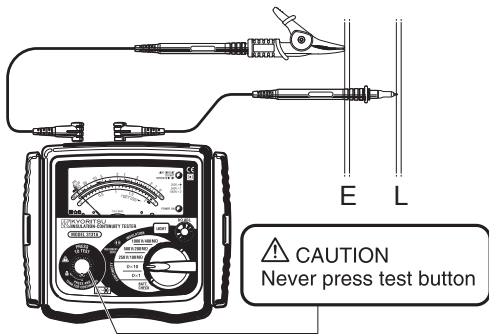

Fig.4

6-2 Insulation Resistance Measurement

⚠ DANGER

- Always test the circuit or equipment to ensure it is surely de-energized before measurement according to the instruction of 6-1.
- To avoid electrical shock, measurements must be performed on de-energized circuits only.
- When the test button is pressed with the range selector switch in the insulation position, take care not to touch the tip of the test probe and the circuit under test where a high voltage is present in order to avoid possible shock hazard.
- Never make measurement with the battery compartment cover removed.
- Always Keep your fingers and hands behind the protective fingerguard on test probe to avoid the possible shock hazard.

⚠ CAUTION

- Never press the test button if the live circuit warning LED is lit or the warning buzzer sounds. This may damage the circuit.
Conduct the voltage warning check before measurement to ensure that the circuit under test is de-energized.

- ① Check the voltage which can be applied to the circuit under test and set the range selector switch to the desired nominal output voltage range.
- ② Connect the earth clip of the test probe (black) to the earth terminal of the circuit under test.
- ③ Put the tip of the line probe (red) to the circuit under test and press the test button.
- ④ Read the scale directly for the 500V range, multiply by 0.5 for 250V and by 2 for 1000V.

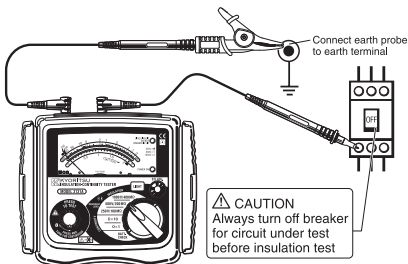

Fig.5 Insulation resistance measurement

⚠ DANGER

Do not touch the circuit under test immediately after testing. Capacitance stored in the circuit may cause electric shock.

Leave the test probe connected to the circuit and never touch the circuit until the discharge is completed.

Principle of Insulation Resistance Measurement

Resistance value can be obtained by applying a certain high voltage to the resistance (insulation resistance) and measuring the flowing current.

Resistance Value = Voltage/Current

$$RX = V/I$$

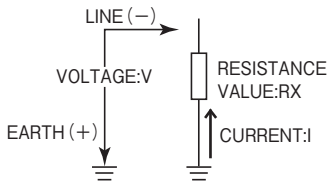

6-3 Continuity Testing (Resistance Tests)

⚠ DANGER

- Always test the circuit or equipment to ensure it is surely de-energized before measurement according to the instruction of 6-1.
- To avoid electrical shock, measurements must be performed on de-energized circuits only.
- Never make measurement with the battery compartment cover removed.
- Always Keep your fingers and hands behind the protective fingerguard on test probe to avoid the possible shock hazard.

⚠ CAUTION

- Never press the test button if the live circuit warning LED is lit or the warning buzzer sounds. This may damage the circuit.
Conduct the voltage warning check before measurement to ensure that the circuit under test is de-energized.
- In case that an additional operating circuit is connected in parallel to the circuit under measurement, the measurement error might be caused due to the effects of impedance of the circuit connected in parallel or transient current.

- ① Set the range selector switch to the desired position x 1 Ω or x 10 Ω.
- ② Short the line probe (red) and the earth clip of the test probe (black) and press the test button. Adjust the ohm zero adjust to zero the pointer on the scale.
- ③ Connect the test probes to the circuit under test and press the test button.
- ④ Read the scale directly for x 1 Ω range, multiply by 10 for x 10 Ω range.

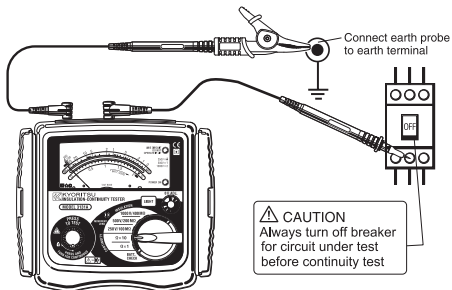

Fig.6

Principle of Continuity Testing (Resistance Test)

Resistance value can be obtained by applying a certain current to the resistance under test and measuring the voltage generated on the both sides of the resistance under test.

$$\text{Resistance Value} = \text{Voltage/Current}$$

$$RX = V/I$$

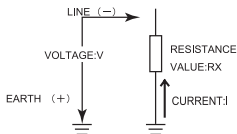

6-4 Continuous Measurement

A lock down feature is incorporated on the test button. Pressing and turning it clockwise, lock the test button in the continuous operating position.

To release the lock turn the test button counterclockwise.

⚠ DANGER

Be extremely careful not to get electric shock during insulation resistance measurement as high voltage is present on the tip of the test probe continuously.

7. Back Light Function

To facilitate working at night or dimly lit situations, a back light function is provided which illuminates the display.

To operate this function, the back light button must be pressed and released while pressing the test button. The back light continues illuminating for approx. 40 seconds and then turn off automatically.

When the test button is released, the back light will turn off even within the lighting time.

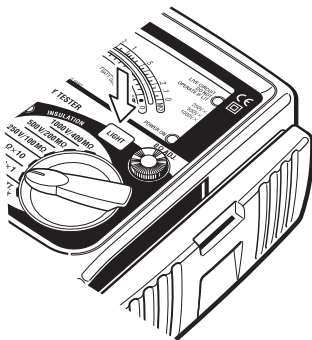

Fig.7 How to use the back light button

8. Battery & Fuse Replacement

⚠ DANGER

- Never open the battery compartment cover while making measurement. To avoid possible electrical shock, disconnect the test probe before opening the cover for battery and fuse replacement.
- Replacement fuse must have the following rating. Fast acting type, F500mA/600V, ϕ 6.35×32mm

8-1 Battery Replacement

- ① Disconnect the test probe from the instrument.
- ② Open the battery compartment cover by unscrewing the metal captive screw to reveal battery compartment. Always replace all six batteries with new ones at the same time.

Battery type: 6 x 1.5V battery type SUM-3, R6, AA or equivalent

8-2 Fuse Replacement

- ① Disconnect the test probe from the instrument.
- ② Open the battery compartment cover by unscrewing the metal captive screw to reveal battery compartment and replace the fuse.

Fuse type: F500mA/600V fast acting ceramic fuse ϕ 6.35 x 32mm

Install batteries in correct polarity as marked inside the case.

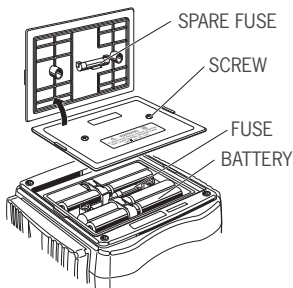

Fig.8 How to replace batteries and fuse

9. Notes on Accessories

9-1 How to Fit Strap Belt and Test Probe Pouch

By hanging the instrument around the neck, both hands can be used freely for easy and safety working.

- ① How to fit the strap belt

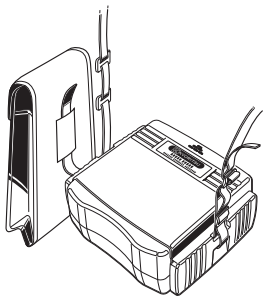

Fig.9 How to fit the strap belt

- ② Whole diagram when the test probe pouch is attached

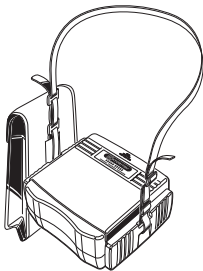

Fig.10 How to fit the test probe pouch

10. Cleaning of the Instrument

© Cleaning the meter cover

This instrument is managed by our company's quality standard and is delivered in the best condition after passed the inspection. But in the dry time of winter static electricity sometimes builds up on the meter cover due to the characteristic of plastic.

When the pointer deflects by touching the surface of this instrument or zero adjustment can not be made, do not try to make measurement.

When static electricity builds up on the meter cover and affects the meter reading, use a cloth dampened with off-the-shelf anti-static agent or detergent to wipe the meter cover surface.

11. Service

If this tester should fail to operate correctly, return it to your nearest distributors stating the exact nature of the fault.

Before returning the unit, make sure that:

- a) probes have been checked.
- b) fuse has been checked.
- c) battery has been checked.

Remember, the more information written about the fault, the quicker it will be serviced.

MEMO

DISTRIBUTOR

92-1487E

6-18

Kyoritsu reserves the rights to change specifications or designs described in this manual without notice and without obligations.



KYORITSU ELECTRICAL INSTRUMENTS WORKS, LTD.

2-5-20, Nakane, Meguro-ku,
Tokyo, 152-0031 Japan
Phone: +81-3-3723-0131
Fax: +81-3-3723-0152
Factory: Ehime, Japan

www.kew-ltd.co.jp