

# 317/319

## Clamp Meter

### Instructions

## Introduction

The Fluke 317 and 319 are hand-held, battery-operated clamp meters (the Product) that measure:

- ac and dc current
- ac and dc voltage
- resistance
- continuity
- frequency

The Product ships with:

- test leads
- soft case
- three AAA batteries (installed)

## Contact Fluke

Fluke Corporation operates worldwide. For local contact information, go to our website: [www.fluke.com](http://www.fluke.com).

To register your product, or to view, print, or download the latest manual or manual supplement, go to our website.

Fluke Corporation  
P.O. Box 9090  
Everett WA 98206-9090  
U.S.A.

Fluke Europe B.V.  
P.O. Box 1186  
5602 BD Eindhoven  
The Netherlands

+1-425-446-5500 [fluke-info@fluke.com](mailto:fluke-info@fluke.com)

## Safety Information

A **Warning** identifies hazardous conditions and procedures that are dangerous to the user. A **Caution** identifies conditions and procedures that can cause damage to the Product or the equipment under test.

### Warning

**To prevent possible electrical shock, fire, or personal injury:**

- **Read all safety information before you use the Product.**
- **Carefully read all instructions.**
- **Do not alter the Product and use only as specified, or the protection supplied by the Product can be compromised.**
- **Do not use the Product if it operates incorrectly.**
- **Do not use the Product if it is altered or damaged.**
- **Use the Product only as specified, or the protection supplied by the Product can be compromised.**

- **Limit operation to the specified measurement category, voltage, or amperage ratings.**
- **Do not touch voltages >30 V ac rms, 42 V ac peak, or 60 V dc.**
- **Do not exceed the Measurement Category (CAT) rating of the lowest rated individual component of a Product, probe, or accessory.**
- **Do not use the Product around explosive gas, vapor, or in damp or wet environments.**
- **Use only correct measurement category (CAT), voltage, and amperage rated probes, test leads, and adapters for the measurement.**
- **Do not use the HOLD function to measure unknown potentials. When HOLD is turned on, the display does not change when a different potential is measured.**
- **Do not work alone.**
- **Do not apply more than the rated voltage, between the terminals or between each terminal and earth ground.**
- **Comply with local and national safety codes. Use personal protective equipment (approved rubber gloves, face protection, and flame-resistant clothes) to prevent shock and arc blast injury where hazardous live conductors are exposed.**
- **Replace the batteries when the low battery indicator shows to prevent incorrect measurements.**
- **Keep fingers behind the finger guards on the probes.**

- Measure a known voltage first to make sure that the Product operates correctly.
- Connect the common test lead before the live test lead and remove the live test lead before the common test lead.
- Remove all probes, test leads, and accessories that are not necessary for the measurement.
- Before each use, examine the Product. Look for cracks or missing pieces of the clamp housing or output cable insulation. Also look for loose or weakened components. Carefully examine the insulation around the jaws.
- Do not use test leads if they are damaged. Examine the test leads for damaged insulation, exposed metal, or if the wear indicator shows. Check test lead continuity.
- Disconnect power and discharge all high-voltage capacitors before you measure resistance, continuity, capacitance, or a diode junction.
- Hold the Product behind the tactile barrier. See [The Product](#) Figure 1 ( **1** ).
- Do not use the Product if the wear indicator in the jaw opening is not visible. See [The Product](#) Figure 2 ( **1** ).
- Do not operate the Product with covers removed or the case open. Hazardous voltage exposure is possible.







- Do not use in CAT III or CAT IV environments without the protective cap installed on test probe. The protective cap decreases the exposed probe metal to <4 mm. This decreases the possibility of arc flash from short circuits.





For safe operation and maintenance of the product:

- Remove batteries to prevent battery leakage and damage to the Product if it is not used for an extended period.
- Be sure that the battery polarity is correct to prevent battery leakage.
- Repair the Product before use if the battery leaks.
- Have an approved technician repair the Product.
- Remove the input signals before you clean the Product.

## Symbols

The table below lists the symbols that can be used on the Product or in this document.

Symbol	Description
	Consult user documentation.
	WARNING. RISK OF DANGER.
	WARNING. HAZARDOUS VOLTAGE. Risk of electric shock.
	Application and removal from hazardous live conductors permitted.
	Double insulated
	Low battery

<b>Symbol</b>	<b>Description</b>
	Earth ground
	Alternating current
	Direct current
	Conforms to European Union directives.
<b>CAT II</b>	Measurement Category II is applicable to test and measuring circuits connected directly to utilization points (socket outlets and similar points) of the low-voltage MAINS installation.
<b>CAT III</b>	Measurement Category III is applicable to test and measuring circuits connected to the distribution part of the building's low-voltage MAINS installation.
<b>CAT IV</b>	Measurement Category IV is applicable to test and measuring circuits connected at the source of the building's low-voltage MAINS installation.
	This product complies with the WEEE Directive marking requirements. The affixed label indicates that you must not discard this electrical/electronic product in domestic household waste. Do not dispose of this product as unsorted municipal waste.

## Software Specifications

<b>Calibration</b>	Full manual calibration and test One-year calibration cycle
<b>Data Integrity and Security</b>	Calibration parameters stored in flash ROM

## General Specifications

<b>Digital Display</b>	6000 count resolution
<b>Clamp Opening Size</b>	37 mm (1.45 in)
<b>Jaw Diameter</b>	37 mm (1.45 in)
<b>Dimensions</b>	162.4 mm x 58.25 mm x 30.5 mm (6.39 in x 2.29 in x 1.20 in)
<b>Weight</b>	~384 g (with batteries)
<b>Battery</b>	3 AAA IEC LR03 batteries
<b>Temperature</b>	
Operating	-10 °C to 50 °C (14 °F to 122 °F)
Storage	-40 °C to 60 °C (-40 °F to 140 °F)
<b>Relative humidity</b>	Non condensing <10 °C (<50 °F) 90 %, 10 °C to 30 °C (50 °F to 86 °F) 75 %, 30 °C to 40 °C (86 °F to 104 °F) 45 % 40 °C to 50 °C (104 °F to 122 °F) (Without Condensation)
<b>Altitude</b>	
Operating	2000 m
Storage	12 000 m
<b>IP Rating</b>	IP40
<b>Safety</b>	IEC 61010-1: Pollution Degree 2 IEC 61010-2-032: CAT III, 600 V

## Electromagnetic Compatibility (EMC)

International IEC 61326-1: Portable Electromagnetic Environment; IEC 61326-2-2, CISPR 11: Group 1, Class A

*Group 1: Equipment has intentionally generated and/or uses conductively-coupled radio frequency energy that is necessary for the internal function of the equipment itself.*

*Class A: Equipment is suitable for use in all establishments other than domestic and those directly connected to a low-voltage power supply network that supplies buildings used for domestic purposes. There may be potential difficulties in ensuring electromagnetic compatibility in other environments due to conducted and radiated disturbances.*

*Caution: This equipment is not intended for use in residential environments and may not provide adequate protection to radio reception in such environments.*

Korea (KCC) Class A Equipment (Industrial Broadcasting & Communication Equipment)

*Class A: Equipment meets requirements for industrial electromagnetic wave equipment and the seller or user should take notice of it. This equipment is intended for use in business environments and not to be used in homes.*



USA (FCC) 47 CFR 15 subpart B. This product is considered an exempt device per clause 15.103.



## Electrical Specifications

The accuracy specification is defined as  $\pm(\% \text{ reading} + \text{digits})$  at  $23\text{ }^{\circ}\text{C} \pm 5\text{ }^{\circ}\text{C}$ .

Function	Parameter	317	319
 <b>A</b> (A ac)	Range	40.00 A 600.0 A	40.00 A 600.0 A 1000 A
	Resolution	0.01 A 0.1 A	0.01 A 0.1 A 1 A
	Accuracy	1.6 % $\pm 6$ digit (50 Hz-60 Hz) [40 A] 2.5 $\pm 8$ digit (60 Hz-500 Hz) [40 A]	1.6 % $\pm 6$ digit (50 Hz-60 Hz) [40 A] 2.5 $\pm 8$ digit (60 Hz-500 Hz) [40 A]
		1.5 % $\pm 5$ digit (50 Hz-60 Hz) [600 A] 2.5 $\pm 5$ digit (60 Hz-500 Hz) [600 A]	1.5 % $\pm 5$ digit (50 Hz-60 Hz) [600/1000 A] 2.5 $\pm 5$ digit (60 Hz-500 Hz) [600/1000 A]
	Crest factor add 2 % into spec for CF >2	3.0 Max @ 500 A 2.5 Max @ 600 A	3.0 Max @ 500 A 2.5 Max @ 600 A 1.4 Max @ 1000 A
AC Response	rms	rms	

Function	Parameter	317	319
 (A dc)	Range	40.00 A 600.0 A	40.00 A 600.0 A 1000 A
	Resolution	0.01 A 0.1 A	0.01 A 0.1 A 1 A
	Accuracy	1.6 % $\pm$ 6 digit [40 A] 1.5 % $\pm$ 5 digit [600 A]	1.6 % $\pm$ 6 digit [40 A] 1.5 % $\pm$ 5 digit [600/1000 A]
 (V ac)	Range	600.0 V	
	Resolution	0.1 V	
	Accuracy	1.5 % $\pm$ 5 digit (20 Hz-500 Hz)	
	AC Response	rms	
 (V dc)	Range	600.0 V	
	Resolution	0.1 V	
	Accuracy	1.5 % $\pm$ 4 digit	
$\Omega$	Range	400.0 $\Omega$ 4000 $\Omega$	
	Resolution	0.1 $\Omega$ 1 $\Omega$	
	Accuracy	1 % 5.0	

Function	Parameter	317	319
)))		≤30 Ω	
Inrush	Integration Time	N/A	100 ms
Hz	Range	N/A	5.0 Hz-500.0 Hz
	Accuracy	N/A	0.5 % ±5 digit
	Trigger Level	N/A	10 Hz-100 Hz ≥5 A, 5 Hz-10 Hz, 100 Hz-500 Hz ≥10 A
<p>The accuracy specifications apply at 23 °C ±5 °C (73 °F ±41 °F). Below 18 °C and above 28 °C (64 °F and above 82 °F) accuracy degrades at (0.1) times specification per °C. True rms for ac V and ac A accuracy is specified from 5 % to 100 % of range.</p>			

## LIMITED WARRANTY

This Fluke product will be free from defects in material and workmanship for 1 years from the date of purchase. This warranty does not cover fuses, disposable batteries, or damage from accident, neglect, misuse, alteration, contamination, or abnormal conditions of operation or handling. Resellers are not authorized to extend any other warranty on Fluke's behalf. To obtain service during the warranty period, contact your nearest Fluke authorized service center to obtain return authorization information, then send the product to that Service Center with a description of the problem.

THIS WARRANTY IS YOUR ONLY REMEDY. NO OTHER WARRANTIES, SUCH AS FITNESS FOR A PARTICULAR PURPOSE, ARE EXPRESSED OR IMPLIED. FLUKE IS NOT LIABLE FOR ANY SPECIAL, INDIRECT, INCIDENTAL OR CONSEQUENTIAL DAMAGES OR LOSSES, ARISING FROM ANY CAUSE OR THEORY. Since some states or countries do not allow the exclusion or limitation of an implied warranty or of incidental or consequential damages, this limitation of liability may not apply to you.

11/99

# The Product

## 1 Clamp Meter

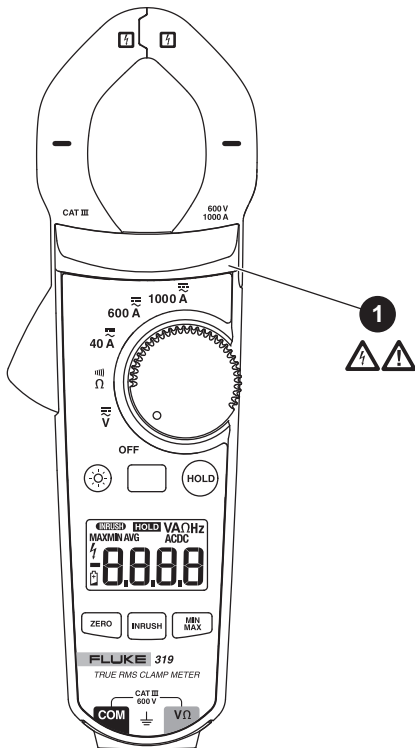

## 2 Jaw Wear

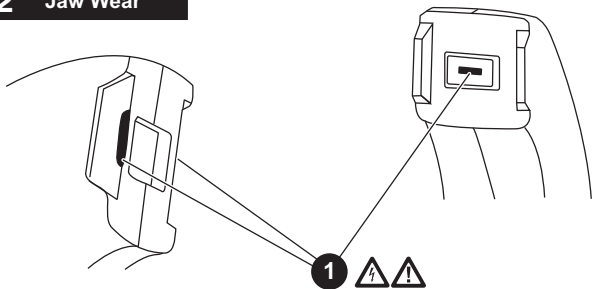

## 3 $\frac{I}{A}$

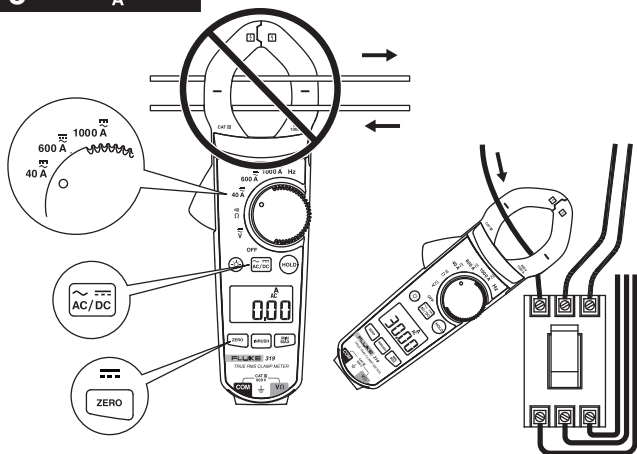

4

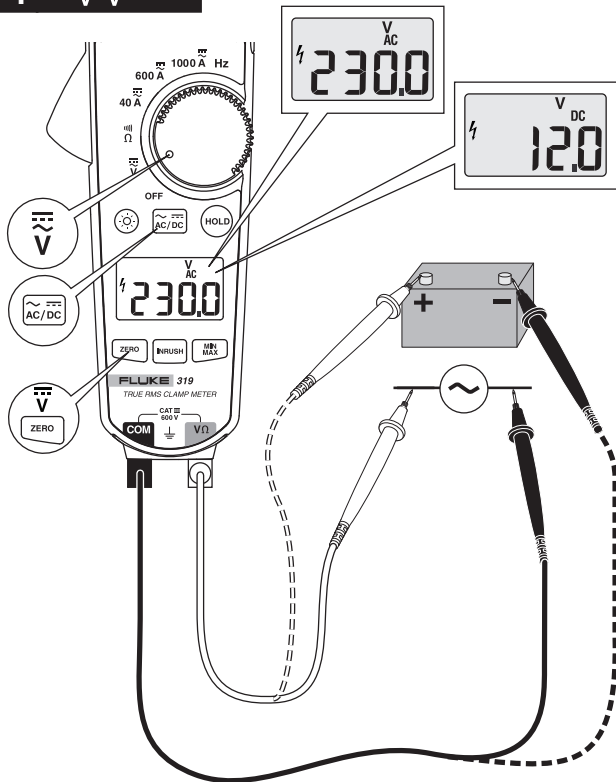

5  $\Omega$

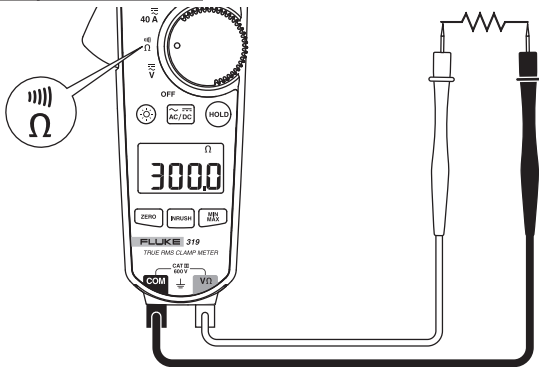

6  $\Omega$

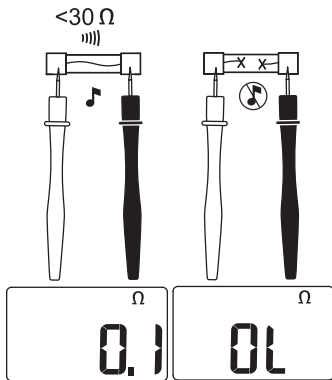
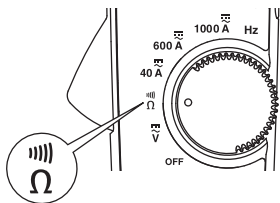



## 7 Display Hold

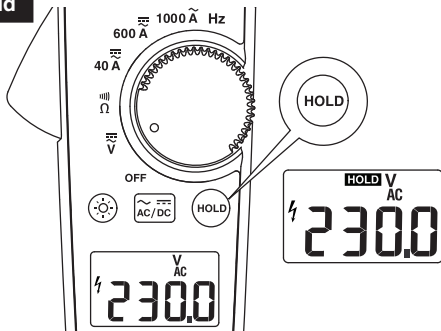

## 8 MIN MAX AVG

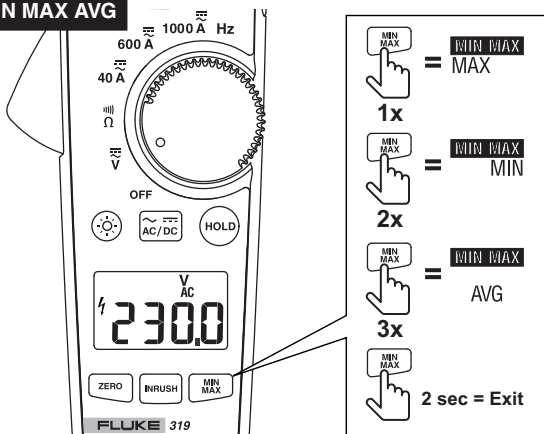

# 9 INRUSH

